

**I**

Gentile Signora, Egregio Signore  
 ci congratuliamo con Lei per la Sua nuova Faema.  
 Con questo acquisto Lei ha scelto una macchina per caffè  
 espresso d'avanguardia costruita secondo i più avanzati  
 principi della tecnica moderna; una macchina che non  
 soltanto è in grado di offrirLe una perfetta sintesi di efficienza  
 e funzionalità ma mette a Sua disposizione tutti gli strumenti  
 per darLe la "sicurezza di lavorare meglio".  
 Il consiglio di dedicare un poco di tempo alla lettura di  
 questo Libretto di Uso e Manutenzione nasce dal desiderio  
 di aiutarLa a prendere confidenza con la Sua nuova  
 macchina; desiderio che siamo certi Lei condividerà  
 pienamente.  
 Le auguriamo buon lavoro.

GRUPPO CIMBALI S.p.A.

**GB**

Dear Customer,  
 We congratulate with you for your new Faema.  
 With this purchase you've chosen an up to date machine,  
 built after the most advanced principles of modern  
 technology, a unit, which gives you not only a perfect  
 synthesis of efficiency and functionality, but puts also at  
 your disposal everything you need for a good working.  
 The advice we give you of spending a bit of your time in  
 reading this manual comes from our desire of helping  
 you in reaching a good knowledge of your new machine.  
 We're sure of finding you of the same advice.  
 With our best wishes of a good work.

GRUPPO CIMBALI S.p.A.

**F**

Cher Client,  
 Nous vous félicitons pour l'acquisition de votre nouvelle  
 Faema.  
 Avec cet achat vous avez choisi une machine à café  
 moderne, construite selon les principes les plus avancés  
 de la technique d'aujourd'hui, une machine qui vous offre  
 une parfaite synthèse d'efficacité et de fonctionnalité et  
 qui met à votre disposition tout ce dont vous avez besoin  
 pour obtenir un bon travail.  
 Le conseil que nous vous donnons de consacrer un peu  
 de votre temps à la lecture de cette brochure vient du désir  
 que nous avons de vous aider à atteindre une bonne  
 connaissance de votre nouvelle machine.  
 Nous sommes certains que vous serez du même avis.  
 Avec nos meilleurs souhaits de bon travail.

GRUPPO CIMBALI S.p.A.

**D**

Sehr geehrter Kunde,  
 Wir gratulieren Ihnen zur Ihrer neuen Faema und heissen  
 sie in unserem Kundenkreis willkommen. Mit diesem  
 Gerät haben Sie eine Maschine ausgewählt, die nach  
 den letzten technischen Entwicklungen auf diesem Sektor  
 gebaut wurde: eine Maschine die mehr als die perfekte  
 Synthese zwischen Leistungsfähigkeit und Funktionalität  
 anbietet: nämlich die Gewissheit, ein betriebsicheres,  
 seinen Aufgaben gewachsenes Gerät zu besitzen.  
 Wir empfehlen Ihnen dieses Handbuch zum Studium,  
 wissend, dass Sie damit Ihre Kenntnisse über Ihre neue  
 Maschine vertiefen können.  
 Wir verbleiben mit unseren besten Wünschen für ein  
 gutes Arbeiten mit Ihrem neuen Gerät.

GRUPPO CIMBALI S.p.A.

**E**

Estimado Cliente,  
 nos felicitamos con Usted para su nueva Faema.  
 Con esta compra Usted ha escogido una máquina para  
 café a la vanguardia, construida según los principios  
 mas adelantados de la técnica moderna; una máquina  
 que no sólo le ofrece una perfecta eficiencia y  
 funcionalidad, mas también le da todo lo que Usted  
 necesita para alcanzar la garantía de un buen trabajo.  
 Le aconsejamos de poner un poco de su atención en la  
 lectura de este manual, consejo que nos viene del deseo  
 de ayudarle a lograr un buen conocimiento de su nueva  
 máquina.  
 Estamos seguros que Usted tiene la misma opinión.  
 Con un deseo particular de buen trabajo.

GRUPPO CIMBALI S.p.A.

**P**

Exm<sup>a</sup>. Senhora, Exm<sup>o</sup>. Senhor,  
 Felicitamo-nos e a si pela sua nova máquina para café.  
 Com deste aquisição escolheu uma máquina para  
 café de vanguarda, construída segundo os mais  
 avançados principios da técnica moderna, uma máquina  
 que está não somente em condições de lhe oferecer  
 uma síntese perfeita de eficiência e funcionalidade, mas  
 põe à sua disposição todos os instrumentos para dar-  
 lhe a "segurança de trabalhar melhor".  
 O conselho de dedicar um pouco de tempo à leitura deste  
 livreto de uso e manutenção nasce do desejo de o ajudar  
 a tomar familiaridade com a sua nova máquina; desejo  
 que estamos certos partilhará plenamente.  
 Desejamos-lhe bom trabalho.

GRUPPO CIMBALI S.p.A.

## Emblema/A



**I** Leggere attentamente le avvertenze contenute nel presente manuale, prima di utilizzare o manipolare in qualsiasi modo la macchina, in quanto forniscono importanti indicazioni riguardanti la sicurezza d'uso della stessa. La macchina per caffè è prevista unicamente per la preparazione di caffè espresso e bevande calde mediante acqua calda o vapore e per il preriscaldamento delle tazzine. Ogni utilizzazione diversa da quella sopra descritta è impropria e può essere fonte di pericolo per persone e macchina. Il produttore non assume responsabilità alcuna in caso di danni risultanti da un uso improprio della macchina per caffè.

**F** Lire attentivement les informations contenues dans ce manuel avant que vous n'utilisiez et que vous ne manipuliez la machine à café de manière erronée. En effet, ces informations vous fourniront d'importantes indications concernant la sécurité d'utilisation de votre machine à café. La machine à café n'est apte qu'à la préparation de cafés espresso et de boissons chaudes, en n'utilisant que de l'eau chaude ou de la vapeur, ou encore, pour chauffer vos tasses. Toute opération différente de celles qui sont indiquées ci-dessus ne peut être effectuée car elle pourrait être la source de dangers pour les personnes et pour la machine même. Le producteur ne s'assume aucune responsabilité dans le cas de dommages provenant d'une utilisation incorrecte de la machine à café.

**E** Leer cuidadosamente las advertencias contenidas en el presente manual antes de utilizar o manejar de cualquier forma la máquina, ya que proporcionan importantes indicaciones sobre la seguridad de manejo de la misma. La máquina para café sólo está prevista para la preparación de café expreso y bebidas calientes mediante agua caliente o por vapor, así como para el calentamiento de las tascitas. Cualquier utilización diferente de la anteriormente descrita es impropia y puede ser fuente de peligro para las personas y la máquina. El fabricante no se asume ninguna responsabilidad en el caso de daños causados por un empleo impropio de la máquina para café.

**GB** Read the instructions in this manual carefully before using or handling the machine in any way. The instructions provide important information regarding the safety precautions to be followed. The coffee machine is to be used solely for preparing espresso coffee and hot drinks made with hot water or steam and for heating cups. Improper use of the machine for operations other than the above can constitute a safety risk to persons and to the equipment. The producer disclaims all liability in case of damage due to improper use of the coffee machine.

**D** Bevor Sie die Maschine einschalten oder gebrauchen, sollten Sie die vorliegende Bedienungsanleitung genau durchlesen, da sie wichtige Angaben zum sicheren Einsatz der Maschine enthält. Die Maschine darf ausschließlich zur Zubereitung von espressokaffee, die Heißwasser- und Dampfausgabe zur Zubereitung von Getränken (z. B. für Teewasser oder zum Milchaufschäumen) oder zum Vorwärmen von Tassen benutzt werden. Alle anderen Arten des Einsatzes gelten als unsachgemäß und beinhalten die Gefahr der Verletzung oder der Beschädigung der Maschine. Der Hersteller übernimmt keine Haftung für Schäden oder Verletzungen, die auf einen unsachgemäßen Einsatz der Kaffeemaschine zurückzuführen wären.

**P** Ler atentamente as advertências contidas no presentemanual, antes de utilizar a máquina ou de a manusear, visto fornecerem indicações importantes relativas à segurança de utilização da mesma. A máquina de café destina-se unicamente à preparação de café expreso e bebidas quentes com água quente ou vapor e para o aquecimento prévio das chávenas. Qualquer utilização diferente das acima descritas é imprópria, podendo tornar-se fonte de perigo para as pessoas e a máquina. O construtor não assume nenhuma responsabilidade perante danos decorrentes de um uso impróprio da máquina de café.

## Indice - Index - Index - Inhaltsverzeichnis - Indice - Índice

Pag. - Page - Page  
Seite - Pag. - Pag.

**Descrizione - Description - Description - Beschreibung - Descripción - Descrição** **4**

**Installazione - Installation - Installation - Installation - Instalación - Instalação** **8**

**Messa fuori servizio definitiva - Dismantling the machine**  
**Endgültige Ausserbetriebstellung - Mise hors service definitive** **27**  
**Interrupción definitiva del servicio - Colocação fora de serviço definitiva**

**I** **Use - Dichiarazione di Conformità CE** **29**  
**PROGRAMMAZIONE - MODALITA' UTENTE** **41**

**GB** **Use - EC Declaration of Conformity** **49**  
**PROGRAMMING - USER MODE** **61**

**F** **Usage - Certificat de Conformité CE** **69**  
**PROGRAMMATION - MODALITES USAGER** **81**

**D** **Gebrauch - EG - Konformitätserklärung** **89**  
**PROGRAMMIERUNG DURCH BENUTZER** **101**

**E** **Use - Declaración de Conformidad CE** **109**  
**PROGRAMACIÓN - MODALIDAD USUARIO** **121**

**P** **Use - Declaração de Conformidade CE** **129**  
**PROGRAMAÇÃO - MODALIDADE DO UTILIZADOR** **141**

**I** **Programmazione - Modalità tecnico** **149**

**GB** **Programming - Engineer mode** **161**

**F** **Programmation – Modalités techniques** **173**

**D** **Programmierung durch Monteur** **185**

**E** **Programación - Modalidad técnico** **197**

**P** **Programação - Modalidades Técnico** **209**

**Schema elettrico - Wiring diagram - Schema électrique** **221**  
**Schaltplan - Esquema electrico - Esquéma electrico**

**Circuito idraulico - Hydraulic circuit - Circuit hydraulique** **228**  
**Hydraulikplan - Circuito hidraulico - Circuito hidráulico**

**Service Line** **232**

Questi capitoli del manuale sono ad uso del personale tecnico autorizzato.

The procedures described in this manual must be performed by qualified technicians.

Ces chapitres du manuel sont utilisables par le personnel technique autorisé.

Die Kapitel der vorliegenden Bedienungsanleitung richten sich an zur Aufstellung, Demontage und Programmierung befugte Techniker.

Estos capítulos del manual son para uso del personal técnico autorizado.

Estes capítulos do manual deverão ser utilizados pelo pessoal técnico autorizado

# Emblema/A

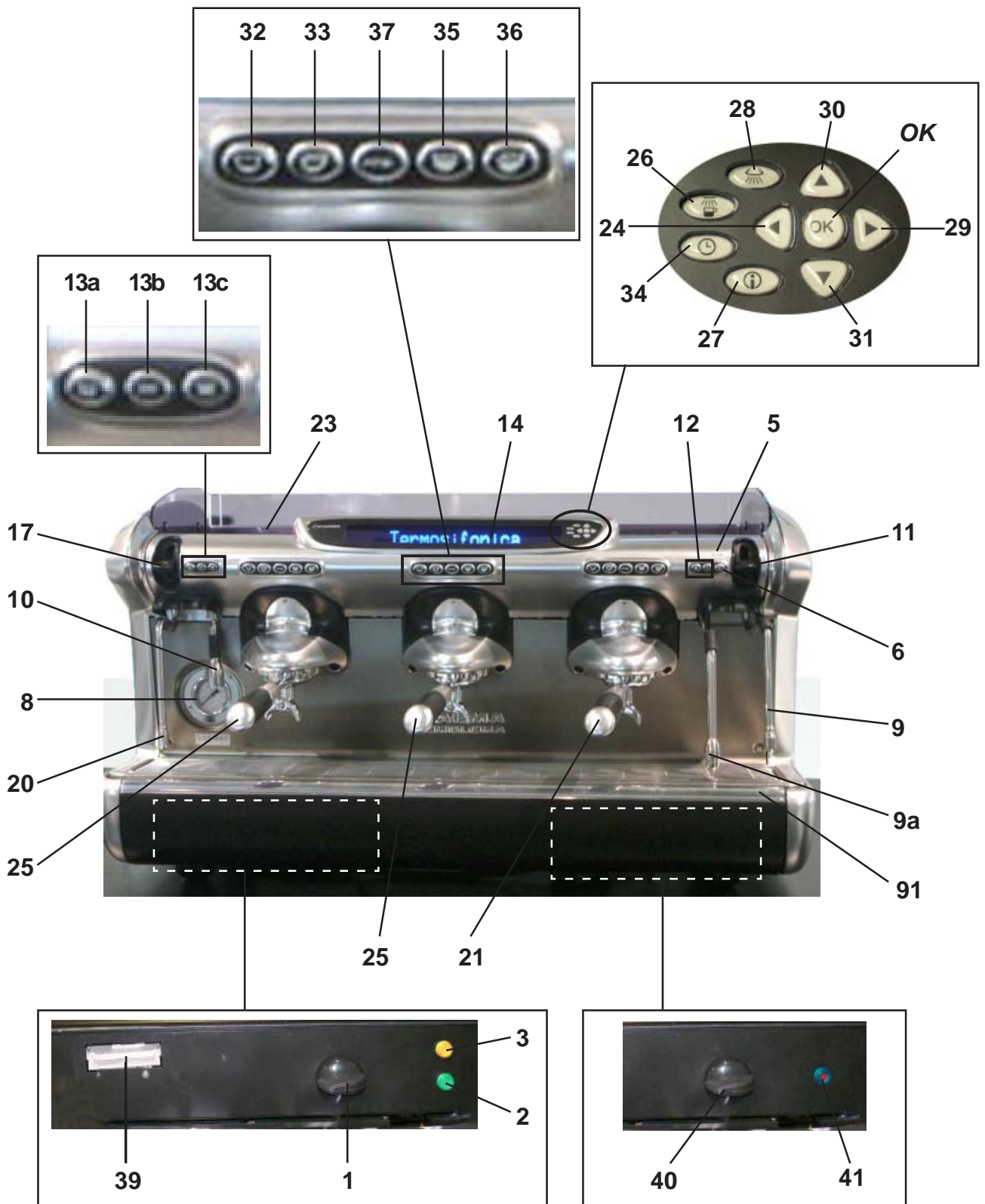

## Legenda - Legend - Legende - Legende - Leyenda - Legenda

### I LEGENDA

- 1 Interruttore generale
- 2 Spia luminosa livello ottimale (verde)
- 3 Spia luminosa (livello) carico acqua in caldaia (arancione)
- 5 Spie luminose scaldatazze acceso (3 LED)
- 6 Pulsante scaldatazze
- 8 Manometro rete/ pompa
- 9 Lancia destra erogazione vapore (\*)
- 9a Tubo (lancia) Turbosteam (\*)
- 10 Lancia erogazione acqua calda
- 11 Leva erogazione vapore lancia (9 dx)
- 12 Pulsante vapore automatico AUTOSTEAM (\*)
- 13a Pulsante erogazione acqua calda (dose 1/STOP)
- 13b Pulsante stop - continuo acqua calda
- 13c Pulsante erogazione acqua calda (dose 2/STOP)
- 14 Display alfanumerico / pubblicitario
- 17 Leva erogazione vapore lancia (20 sx)
- 20 Lancia sinistra erogazione vapore
- 21 Portafiltro per una tazza
- 23 Piano appoggiatezze
- 24 Tasto "RES" (uscire dalla programmazione / invalidazione dati immessi)
- 25 Portafiltro per due tazze
- 26 Tasto lavaggio circuito caffè
- 27 Tasto "i" (visualizzazione numero cicli)
- 28 Tasto lavaggio circuito latte
- 29 Tasto "PRG" (entrare in programmazione / menù)
- 30 Tasto "+" (modificare parametri / orologio)
- 31 Tasto "-" (modificare parametri / orologio)
- 32 Pulsante erogazione un caffè ristretto
- 33 Pulsante erogazione due caffè ristretti
- 34 Tasto "PARAMETRICLIENTE"
- 35 Pulsante erogazione un caffè lungo
- 36 Pulsante erogazione due caffè lunghi
- 37 Pulsante erogazione continua/STOP
- 39 Feritoia carta servizi (programmazione tecnico) (\*)
- 40 Manopola-pulsante rubinetto gas (\*)
- 41 Pulsante accensione piezoelettrica (\*)
- 91 Bacinella appoggiatezze
- OK Pulsante attivazione / disattivazione resistenza caldaia - conferma dati immessi

I componenti - \* - sono applicati solo su alcune configurazioni di prodotti.

### GB LEGEND

- 1 Main switch
- 2 Optimum level Indicator light (green)
- 3 Boiler water fill indicator (level) light (orange)
- 5 Cup warmer "ON" indicator light (3 LED)
- 6 Cupwarmer button
- 8 Pump pressure gauge
- 9 Right steam wand (\*)
- 9a Turbosteam pipe (\*)
- 10 Hot water wand
- 11 Steam lever (9 dx)
- 12 Automatic steam button AUTOSTEAM (\*)
- 13a Hot water touche button (dose 1/STOP)
- 13b Stop button, continuous hot water
- 13c Hot water touche button (dose 2/STOP)
- 14 Alphanumeric display / Promotional display
- 17 Steam lever (20 sx)
- 20 Left steam delivery wand
- 21 Filter-holder for one cup
- 23 Cups warmer
- 24 "RES" key (to quit programming mode / cancel entered data)
- 25 Filter-holder for two cups
- 26 Coffee circuit flushing key
- 27 "i" key (displays the number of cycles)
- 28 Milk circuit wash key
- 29 "PRG" key (to access programming mode / menu)
- 30 "+" key (to modify parameters / clock)
- 31 "-" key (to modify parameters / clock)
- 32 One coffee key long
- 33 Two coffees key long
- 34 "CUSTOMER PARAMETERS" key
- 35 One coffee key short
- 36 Two coffees key short
- 37 Continue / STOP key
- 39 Card services slit (technical programming) (\*)
- 40 Gas tap-button (\*)
- 41 Piezoelectric lighter push-button (\*)
- 91 Cup rest tray
- OK On / Off switch boiler resistance - confirm entered data

Items marked - \* - are fitted in some product configurations only.



## Legenda - Legend - Legende - Legende - Leyenda - Legenda

### F LEGENDE

- 1 Interrupteur général
- 2 Témoin lumineux niveau optimal (verte)
- 3 Voyant lumineux (niveau) charge de l'eau dans la chaudière (orange)
- 5 Témoin lumineux chauffe-tasses allumé (3 LED)
- 6 Bouton poussoir chauffe-tasses
- 8 Manomètre
- 9 Lance droite de débit vapeur (\*)
- 9a Tuyau Turbosteam (\*)
- 10 Lance de débit d'eau chaude
- 11 Levier de débit de lance vapeur (**9 droite**)
- 12 Bouton poussoir vapeur automatique AUTOSTEAM (\*)
- 13a Clavier débit d'eau chaude (dose 1/STOP)
- 13b Bouton poussoir stop - continue eau chaude
- 13c Clavier débit d'eau chaude (dose 2/STOP)
- 14 Display alphanumérique / Ecran publicitaire
- 17 Levier de débit pour lance vapeur lance (**20 sx**)
- 20 Lance gauche de débit vapeur
- 21 Porte-filtre pour une tasse
- 23 Chauffe-tasses
- 24 Touches "**RES**" (sortir de la programmation / données introduites non valables)
- 25 Porte-filtre pour deux tasses
- 26 Touches de lavage du circuit café
- 27 Touches "**i**" (affiche nombre des cycles)
- 28 Touche lavage circuit lait
- 29 Touches "**PRG**" (entrer en programmation / menu)
- 30 Bouton "+" (modifier les paramètres / horloge)
- 31 Bouton "-" (modifier les paramètres / horloge)
- 32 Touche de débit de café restreint
- 33 Touche de débit de deux cafés restreints
- 34 Touche "**PARAMÈTRES CLIENT**"
- 35 Touche de débit de café long
- 36 Touche de débit de deux cafés longs
- 37 Touche de débit continu / STOP
- 39 Fente de carte services (programmation technique) (\*)
- 40 Bouton-bouton poussoir robinet du gaz (\*)
- 41 Interrupteur d'allumage de la plaque électrique (\*)
- 91 Cuve appui-tasses
- OK Bouton poussoir d'activation /désactivation résistance chaudière - confirmation des données introduites

Les détails - \* - ne sont appliqués qu'à certaines configurations de produit.

### D LEGENDE

- 1 Hauptschalter
- 2 Kontrolleuchte optimale Stand (grün)
- 3 Kontrolleuchte (Standanzeige) Wasserzuführung in Kessel (orange)
- 5 Kontrolleuchte Tassenvorwärmer (3 LED)
- 6 Taste „Tassenvorwärmer“
- 8 Manometer
- 9 Dampfrohr rechts
- 9a Dampfausgaberohr turbosteam \*
- 10 Heißwasserausgabe
- 11 Hebel Dampfausgabe (**9 Rechtes**)
- 12 Taste „automatische Dampfabgabe“ AUTOSTEAM (\*)
- 13a Heißwasserausgabe (Dosis 1/STOP)
- 13b Stopp-Taste (Fortsetzung Heißwasserabgabe)
- 13c Heißwasserausgabe (Dosis 2/STOP)
- 14 Display alfanymmering / Werbedisplay
- 17 Hebel Dampfausgabe (**20 Linkes**)
- 20 Dampfrohr links
- 21 Filterhalter für 1 Tasse
- 23 Tassenerwärmer
- 24 Taste „**RES**“ (Absprung von Programmierung/Löschen der eingegebenen Daten)
- 25 Filterhalter für 2 Tassen
- 26 Taste zum Durchspülen des Kaffeekreislaufs
- 27 Taste „**i**“ (Anzeige der Zyklus-Nr.)
- 28 Taste Spülung Milchkreis
- 29 Taste „**PRG**“ (Zugriff zu Programmierung / Menü)
- 30 Taste „+“ (Parameter / Uhrzeit ändern)
- 31 Taste „-“ (Parameter / Uhrzeit ändern)
- 32 Taste Kaffeeausgabe 1 Tasse (Ristretto)
- 33 Taste Kaffeeausgabe 2 Tassen (Ristretto)
- 34 Taste „**KUNDENPARAMETER**“
- 35 Taste Kaffeeausgabe 1 Tasse (gross)
- 36 Taste Kaffeeausgabe 2 Tassen (gross)
- 37 Taste Kaffeeausgabe kontinuierlich und STOP
- 39 Einsteckschlitz für Servicekarte (Programmierung durch Techniker) (\*)
- 40 Regler-Taste Gasventil (\*)
- 41 Taste piezoelektrische Zündung (\*)
- 91 Wanne zur Tassenablage
- OK Taste zur Aktivierung / Deaktivierung des Heizelements Wasserkessel - Bestätigung der eingegebenen Daten

Die mit - \* - gekennzeichneten Komponenten sind nur in bestimmten Modellen installiert.

## Legenda - Legend - Legende - Legende - Leyenda - Legenda

### **E** LEYENDA

- 1 Interruptor general
- 2 Indicador luminoso nivel óptimo (verde)
- 3 Indicador luminoso (nivel) carga agua en la caldera (naranja)
- 5 Indicador luminoso calienta-tazas encendido (3 LED)
- 6 Botón calienta-tazas
- 8 Manómetro
- 9 Tubo derecho erogación vapor (\*)
- 9a Tubo vapor turbosteam \*
- 10 Tubo erogación agua caliente
- 11 Palanca erogación vapor tubo(9 derecha)
- 12 Botón vapor automático AUTOSTEAM (\*)
- 13a Botón erogación agua caliente (dosis 1/STOP)
- 13b Botón stop – continuo agua caliente
- 13c Botón erogación agua caliente (dosis 2/STOP)
- 14 Visualizador alfanumérico / publicitario
- 17 Palanca erogación vapor tubo (20 sx)
- 20 Tubo izquierdo erogación vapor
- 21 Portafiltro para una taza
- 23 Calientatazas
- 24 Tecla **"RES"** (salir de la programación / invalidación datos introducidos)
- 25 Portafiltro para dos tazas
- 26 Tecla lavado circuito café
- 27 Tecla **"i"** (visualización número ciclos)
- 28 Tecla lavado circuito leche
- 29 Tecla **"PRG"** (entrar en programación / menú)
- 30 Tecla **"+"** (modificar parámetros / reloj)
- 31 Tecla **"-"** (modificar parámetros / reloj)
- 32 Botón erogación un café corto
- 33 Botón erogación dos cafés cortos
- 34 Tecla **"PARAMETROS USUARIO"**
- 35 Botón erogación un café largo
- 36 Botón erogación dos cafés largos
- 37 Botón erogación continua/STOP
- 39 Raja de la tarjeta servicios (programación técnica) (\*)
- 40 Mango-botón grifo gas (\*)
- 41 Botón encendido piezoeléctrico (\*)
- 91 Bandeja apoya-tazas
- OK** Botón activación / desactivación resistencia caldera - confirmación datos introducidos

Los detalles - \* - se pueden aplicar sólo en algunas configuraciones del producto.

### **P** LEGENDA

- 1 Interruptor geral
- 2 Indicador luminoso nível óptimo (verde)
- 3 Indicador luminoso (nível) de carregamento da água na caldeira (laranja)
- 5 Indicadores luminosos do aquecedor de chávenas aceso (3 LED)
- 6 Botão do aquecedor de chávenas
- 8 Manómetro rede/bomba
- 9 Lança direita de distribuição do vapor (\*)
- 9a Tubo do vapor turbosteam \*
- 10 Lança de distribuição da água quente
- 11 Alavanca de distribuição do vapor na lança (9 dir)
- 12 Botão de vapor automático AUTOSTEAM (\*)
- 13a Botão de distribuição da água quente (dose 1/ STOP)
- 13b Botão stop – contínuo da água quente
- 13c Botão de distribuição da água quente (dose 2/ STOP)
- 14 Mostrador alfanumérico / publicitário
- 17 Alavanca de distribuição do vapor lança (20 esq)
- 20 Lança esquerda de distribuição do vapor
- 21 Porta-filtro para uma chávena
- 23 Grelha para esquentar chávenas
- 24 Tecla **"RES"** (sair da programação / invalidação dos dados introduzidos)
- 25 Porta-filtro para duas chávenas
- 26 Tecla de lavagem de circuito café
- 27 Tecla **"i"** (visualização do número de ciclos)
- 28 Tecla lavagem circuito leite
- 29 Tecla **"PRG"** (entrar na programação / menu)
- 30 Tecla **"+"** (modificar parâmetros / relógio)
- 31 Tecla **"-"** (modificar parâmetros / relógio)
- 32 Botão de distribuição de um café forte
- 33 Botão de distribuição de dois cafés fortes
- 34 Tecla **"PARAMETROS CLIENTE"**
- 35 Botão de distribuição de dois cafés cimbálinos
- 36 Botão de distribuição de dois cafés cimbálinos
- 37 Botão de distribuição contínua /STOP
- 39 Régua do cartão serviços (programação técnica) (\*)
- 40 Manípulo-botão da torneira do gás (\*)
- 41 Botão acendimento piezoelétrica (\*)
- 91 Bacia para apoiar as chávenas
- OK** Botão activação / desactivação resistência caldeira - confirmação dos dados introduzidos

Os componentes " \* " – são aplicados apenas sobre algumas configurações de produtos

I



**ATTENZIONE**

L'installazione, lo smontaggio e le regolazioni devono essere eseguite esclusivamente da personale tecnico qualificato.

GB



**ATTENTION**

Installation, disassembly and setting should be carried out by qualified technical personnel only.

F



**ATTENTION**

L'installation, le démontage et les réglages doivent être faits uniquement par le personnel technique qualifié et autorisé.

D



**ACHTUNG!**

Die Installation, die Demontage und die Einstellung des Gerätes darf nur durch entsprechend qualifizierte Fachkräfte vorgenommen werden.

E



**ATENCIÓN**

Las operaciones de instalación, desmontaje y regulación tienen que ser realizadas por personal técnico capacitado.

P



**ATENÇÃO**

A instalação, a desmontagem e as regulações terão de ser executadas exclusivamente por pessoal técnico qualificado.



## Installazione - Installation - Installation - Installation - Instalación - Instalação

I



### INDICAZIONI PER L'INSTALLAZIONE

1. Leggere attentamente le avvertenze contenute nel presente libretto in quanto forniscono importanti indicazioni riguardanti la sicurezza di installazione, d'uso e di manutenzione. Conservare con cura questo libretto per ogni ulteriore consultazione.
2. Questo apparecchio dovrà essere destinato solo all'uso per il quale è stato espressamente concepito. Il costruttore non può essere considerato responsabile per eventuali danni derivanti da usi impropri, erronei ed irragionevoli.
3. Dopo aver tolto l'imballaggio assicurarsi dell'integrità dell'apparecchio. Gli elementi dell'imballaggio (sacchetti in plastica, polistirolo espanso, chiodi, ecc.) non devono essere lasciati alla portata dei bambini in quanto potenziali fonti di pericolo.
4. Prima di collegare l'apparecchio accertarsi che i dati di targa siano rispondenti a quelli della rete di distribuzione elettrica e idrica.
5. La macchina per caffè deve essere appoggiata su una superficie piana e stabile, ad una distanza minima di 20 mm dalle pareti e dalla superficie d'appoggio. Inoltre deve essere installata tenendo conto che la superficie d'appoggio più alta (scaldatozze) sia ad un'altezza non inferiore a 1,5 metri. La temperatura ambiente deve essere compresa tra 0 e 32°C.
6. Deve avere i collegamenti di alimentazione (energia elettrica ed acqua) e lo scarico dell'acqua dotato di sifone nelle immediate vicinanze; inoltre occorre prevedere una superficie di appoggio per gli accessori.
7. All'installazione occorre prevedere un interruttore onnipolare con distanza di apertura dei contatti uguale o superiore a 3 mm e una protezione da corrente di dispersione con valore pari a 30 mA.
8. La sicurezza elettrica di questo apparecchio è assicurata soltanto quando lo stesso è correttamente collegato ad un efficace impianto di messa a terra come previsto dalle vigenti norme di sicurezza elettrica. E' necessario verificare questo fondamentale requisito di sicurezza e, in caso di dubbio, richiedere un controllo accurato dell'impianto da parte di personale professionalmente qualificato. Il costruttore non può essere considerato responsabile per eventuali danni causati dalla mancanza di messa a terra dell'impianto.
9. In generale è sconsigliabile l'uso di adattatori, prese multiple e/o prolunghe. Qualora il loro uso si rendesse indispensabile è necessario utilizzare solamente adattatori semplici o multipli e prolunghe conformi alle vigenti norme di sicurezza, facendo però attenzione a non superare il limite di portata in valore di corrente, marcato sull'adattatore semplice e sulle prolunghe, e quello di massima potenza marcato sull'adattatore multiplo.
10. Per evitare surriscaldamenti pericolosi, si raccomanda di svolgere per tutta la sua lunghezza il cavo di alimentazione.
11. Per salvaguardare le caratteristiche di funzionalità e di sicurezza, si raccomanda di non lasciare la macchina per caffè esposta ad agenti atmosferici (pioggia, sole, gelo).
12. Non installare in locali (cucine) in cui sia prevista la pulizia mediante getti d'acqua. In ogni caso, evitare di pulire l'apparecchio con getti d'acqua.
13. Non ostruire le aperture o fessure di ventilazione o di smaltimento calore.
14. In caso di danneggiamento del cavo di alimentazione, lo stesso deve essere sostituito solo dall'assistenza tecnica autorizzata.
15. Se la macchina viene immagazzinata in locali in cui la temperatura può scendere sotto il punto di congelamento, vuotare in ogni caso la caldaia e le tubazioni di circolazione acqua.

GB



### NOTICE FOR THE SERVICEMAN

1. Carefully read the instruction herein, which contain important information for safe installation, use and maintenance. Keep this booklet on hand for further reference.
2. This appliance shall only be used for its specific purpose. The manufacturers shall not be liable for damages due to improper, wrong or unreasonable use.
3. Unpack and check machine for soundness. Do not leave packaging components ( plastic bags, expanded polystyrene, nails, etc.) within children's reach, as they represent potential hazards.
4. Prior to plugging in, check that nameplate data correspond with those of the electric and water mains.
5. The coffee machine should be placed on a stable flat surface with the bodywork at a minimum distance of 20 mm from the supporting surface and the walls. Furthermore, it must be installed taking into account that the highest shelf (cup warmer) must sit at a height that is at least 1.5 meters.  
Room temperature must range between 0 and 32°C (32÷89.6°F).
6. The (electricity and water) supply connections and a water outlet fitted with a siphon should be close to the machine. A support surface should also be available for accessories.
7. Install an omnipolar switch with minimum 3 mm. gap between contacts and 30 mA dispersion-current protection.
8. This appliance is electrically safe only when properly earthed as set forth in the current electric safety specifications. Check for compliance and, when in doubt, have the wiring thoroughly inspected by skilled personnel. The manufacturers shall not be liable for any damage caused by faulty earthing.
9. Using adapters, multiple plugs and cable extensions is not recommended. Should they be indispensable, use simple or multiple adapters and extensions that comply with the current safety regulations, take care not to exceed the limit current load shown on simple adapters and extensions, and the limit power load shown on multiple adapters.
10. To prevent dangerous overheating, uncoil the power cable to its full length.
11. To ensure correct operation and safety, the coffee machine should not be exposed to outdoor weather conditions (rain, sun, ice).
12. Do not install in rooms (kitchens) cleaned using water jets. At any rate, avoid cleaning the machine with water jets.
13. Do not plug or clog the ventilation and heat-exhausting louvers.
14. If the machine's electrical cord is damaged, it should be replaced. This should only be done by an authorized service technician.
15. If the machine is stored on premises where the temperature may drop below freezing point, always empty the boiler and the water circulation pipes

## Installazione - Installation - Installation - Installation - Instalación - Instalação

F



### INDICATIONS POUR L'INSTALLATION

1. Lire attentivement les avertissements contenus dans le présent livret du fait qu'ils fournissent d'importantes indications concernant la sécurité d'installation, d'utilisation et d'entretien. Conserver ce livret avec soin pour toute consultation ultérieure.
2. Cet appareil dévora être employé seulement par l'usage par le quel a été expressivement construit. Le constructeur ne peut être tenu pour responsable des dommages éventuels provoqués par usage impropres, erronées ou non corrigés.
3. Après avoir retiré l'emballage, s'assurer de l'intégrité de l'appareil. Les éléments de l'emballage (sachets de plastique, polystyrène expansé, clous, etc.) ne doivent pas être laissées à la portée des enfants dans la mesure où ils constituent des sources de danger potentielles.
4. Avant de brancher, l'appareil s'assurer que les donnée de la plaque correspondent à celles du réseau de distribution électrique et hydrique.
5. La machine pour café doit être placée sur une surface plate et stable, à une distance minimum de 20 mm des cloisons et de la surface d'appui. En outre, elle doit être installée en tenant compte du fait que la surface d'appui la plus élevée (chauffe-tasses) se trouve bien à une hauteur qui n'excède pas 1,5 m. La température ambiante doit être comprise entre 0 et 32°C.
6. Elle doit avoir les connexions d'alimentation (énergie électrique et eau) ainsi que le déchargement de l'eau, doté de siphon à un endroit très proche; en outre, vous devrez prévoir un plan d'appui pour les accessoires de la machine.
7. Lors de l'installation, il convient de prévoir un interrupteur omnipolaire avec un écartement des contacts supérieur ou égal à 3 mm et protection contre la dispersion de courant ayant une valeur égale à 30 mA.
8. La sécurité électrique de cet appareil est assurée seulement lorsqu'il est correctement raccordé à une installation de mise à terre efficace, comme prévu par les normes de sécurité électrique en vigueur. Il est nécessaire de vérifier cette condition fondamentale de sécurité et, en cas de doute, de demander un contrôle complet de l'installation par du personnel professionnellement qualifié. Le constructeur ne peut être tenu pour responsable des dommages éventuels provoqués par la non mise à terre de l'installation.
9. En général, il est déconseillé d'utiliser des adaptateurs, prises multiples et/ou des rallonges. S'avérerait au cas où leur utilisation indispensable, il est nécessaire d'utiliser seulement des adaptateurs simples ou multiples et des rallonges conformes aux normes de sécurité en vigueur, en prêtant cependant attention à ne pas dépasser la limite de débit maximum en valeur de courant, indiquée sur l'adaptateur simple et sur les rallonges, ou celle de puissance maximum figurant sur l'adaptateur multiple.
10. Afin d'éviter des surchauffes dangereuses, on recommande de dérouler le câble d'alimentation sur toute sa longueur.
11. Pour sauvegarder les caractéristiques de bon fonctionnement et de sécurité de votre machine à café, il est recommandé de ne pas l'exposer à des agents atmosphériques tels que la pluie, le soleil, le gel, etc...
12. Ne pas installer votre machine à café dans des pièces (sur une cuisinière par exemple) où l'on prévoit un nettoyage par jets d'eau. De toute façon, éviter de nettoyer l'appareil par jets d'eau.
13. Ne pas obstruer les ouvertures ou fentes de ventilation et d'évacuation de la chaleur.
14. Si le câble d'alimentation est endommagé, s'adresser uniquement à un centre d'assistance technique autorisé pour le substituer.
15. Si l'appareil devait être mis dans des pièces où la température pourrait descendre sous un degré de congélation, vider de toute manière la chaudière ainsi que les conduites de circulation de l'eau.

D



### ANGABEN ZUR INSTALLATION

1. Die im vorliegenden Anleitungsheft enthaltenen Anweisungen sind aufmerksam zu lesen, da sie wichtige Hinweise zur Installation, Bedienungs- und Wartungssicherheit liefern. Dieses Anleitungsheft ist zum späteren Nachschlagen sorgfältig aufzubewahren.
2. Dieses Gerät darf ausschließlich nur für den vorgesehenen Verwendungszweck eingesetzt werden. Der Hersteller kann nicht für eventuelle eintretende Schäden herangezogen werden, die auf unsachgemäßen, fehlerhaften oder fahrlässigen Gebrauch zurückzuführen sind.
3. Nach Entfernung des Verpackungsmaterials ist das Gerät auf Unversehrtheit zu überprüfen. Das Verpackungsmaterial (Kunststoffbeutel, Styropor, Nägel usw.) kann für Kinder gefährlich sein - halten Sie es von ihnen fern.
4. Bevor Sie das Gerät anschließen, vergewissern Sie sich, daß die Angaben auf dem Typenschild den Lieferwerten des Strom- und des Wassernetzes entsprechen.
5. Stellen Sie die Kaffeemaschine auf eine stabile und ebene Fläche, in einem Abstand von mindestens 20 mm zu den Wänden und zur Aufstellfläche. Die Maschine muß so installiert werden, daß die Bodenhöhe der höchsten Auflagefläche (Tassenwärmer) wenigstens 1,5 m beträgt. Die Umgebungstemperatur muß im Bereich 0 bis 32°C liegen.
6. Vergewissern Sie sich, dass in unmittelbarer Nähe der Aufstellungsfläche die verschiedenen Anschlüsse zur Versorgung der Maschine (Strom und Wasser) sowie ein Ablauf mit Syphon vorhanden sind und dass eine weitere Fläche zur Ablage der Zubehöerteile vorhanden ist.
7. Bei der Installation des Geräts ist ein allpoliger Schalter mit einer Kontaktöffnungsweite von mindestens 3 mm. vorzusehen und fehlerstromschutz für 30 mA.
8. Die elektrische Betriebssicherheit dieses Geräts ist nur gewährleistet, wenn es sachgerecht mit einer wirksamen Erdschlußanlage verbunden ist, wie von den einschlägigen Bestimmungen zur Sicherheit von Elektroanlagen vorgesehen. Es muß garantiert sein, daß diese grundlegende Sicherheitsanforderung erfüllt wird; lassen Sie im Zweifelsfall eine sorgfältige Kontrolle der Elektroanlage durch qualifiziertes Fachpersonal vornehmen. Der Hersteller kann nicht für eventuelle Schäden herangezogen werden, die auf mangelnde Erdung der Elektroanlage zurückzuführen sind.
9. Vom Gebrauch von Stecker-Adaptern, Mehrfachsteckern und/oder Verlängerungskabeln wird allgemein abgeraten. Sollte ihre Verwendung unerlässlich sein, dürfen ausschließlich Ein- bzw. Mehrfach-Adapter und Verlängerungskabel benutzt werden, die den einschlägigen Sicherheitsbestimmungen entsprechen; man muß jedoch sicherstellen, daß bei Einfach-Adaptern und Verlängerungskabeln der darauf markierte Stromabgabe-Grenzwert nicht überschritten wird bzw. der markierte Leistungs-Höchstwert bei Mehrfach-Adaptern.
10. Um gefährliche Überhitzungen zu verhüten, empfiehlt es sich, das Speisungskabel in seiner ganzen Länge abzuwickeln.
11. Um eine einwandfreie Funktion und den sicheren Betrieb der Maschine zu gewährleisten, darf die Kaffeemaschine keinen kritischen Umgebungsbedingungen (Regen, starke Sonneneinstrahlung, Frost) ausgesetzt werden.
12. Stellen Sie die Maschine nicht in Räumen auf (z. B. Küche), in denen eine Reinigung mittels Wasserstrahl vorgesehen ist. In jedem Fall darf die Maschine nicht mittels Wasserstrahlen gereinigt werden.
13. Die Öffnungen oder Schlitze zur Belüftung bzw. zur Wärmeableitung sind frei zu halten.
14. Wenn das Netzkabel beschädigt wird, darf es nur durch einen autorisierten Kundendiensttechniker ersetzt werden.
15. Sollte die Maschine in Räumen gelagert werden, in denen Frostgefahr gegeben ist, so müssen in jedem Falle sowohl der Wassertank als auch die Leitungen des Wasserkreises geleert werden.

## Installazione - Installation - Installation - Installation - Instalación - Instalação

**E**



### INDICACIONES PARA LA INSTALACIÓN

1. Leer atentamente las advertencias contenidas en el presente manual ya que las mismas suministran importantes indicaciones con respecto a la seguridad de instalación, de uso y de mantenimiento. Conservar con cuidado este manual para cualquier ulterior consulta.
2. Este aparato deberá ser destinado solo para el uso para el cual ha sido expresamente concebido. El fabricante no puede ser considerado responsable de los eventuales daños derivados por usos impropios, erróneos o irracionales.
3. Después de haber quitado el embalaje, controlar la integridad del aparato. Los elementos del embalaje (bolsitas de plástico, poliestireno expandido, clavos, etc.) no deben ser dejados al alcance de los niños ya que constituyen potenciales fuentes de peligro.
4. Antes de conectar el aparato, controlar que los datos de la placa correspondan a los de la red de distribución eléctrica e hídrica.
5. La máquina para café se tiene que apoyar sobre una superficie plana y estable, a una distancia mínima de 20 mm de las paredes y de la superficie de apoyo. Además se tiene que instalar teniendo en cuenta que la superficie de apoyo más alta (calienta-tazas) esté a una altura no inferior a 1,5 metros.  
La temperatura ambiente tiene que estar incluida entre 0 y 32°C.
6. Tiene que tener las conexiones de alimentación (energía eléctrica y agua) y el desagüe del agua equipado con un sifón cerca, además hay que prever una superficie de apoyo para los accesorios.
7. En el momento de la instalación es necesario prever un interruptor omnipolar con distancia de abertura de los contactos igual o superior a 3 mm y una protección contra corriente de dispersión con valor de 30 mA.
8. La seguridad eléctrica de este aparato está asegurada solamente cuando el mismo se halla correctamente conectado con una eficaz instalación de puesta a tierra, según lo previsto por las normas de seguridad eléctrica en vigor. Es necesario controlar este fundamental requisito de seguridad y, en caso de duda, requerir un cuidadoso control de la instalación por parte de personal profesionalmente cualificado. El fabricante no puede ser considerado responsable de los eventuales daños causados por la falta de puesta a tierra de la instalación.
9. En general no es aconsejable el uso de adaptadores, tomas múltiples y/o extensiones. En el caso de que el uso de los mismos fuera indispensable, es necesario utilizar solamente adaptadores simples o múltiples y extensiones conformes a las normas de seguridad en vigor, prestando atención a no superar el límite de alcance en valor de corriente, marcado en el adaptador simple o en las extensiones, o el de máxima potencia marcado en el adaptador múltiple.
10. Para evitar peligrosos recalentamientos, se recomienda desenvolver en toda su longitud el cable de alimentación.
11. Para salvaguardar las características de funcionalidad y de seguridad, se aconseja no dejar la máquina de café expuesta a la acción de los agentes atmosféricos (lluvia, sol, hielo).
12. No instalar en locales (cocinas) en los que se prevea la limpieza mediante chorros de agua. En cualquier caso, evitar la limpieza del aparato con chorros de agua.
13. No obstruir las aberturas u orificios de ventilación o de dispersión de calor.
14. En caso de que el cable de alimentación resulte dañado, el mismo debe ser substituido sólo por la asistencia técnica autorizada.
15. Si la máquina se almacena en locales en los que la temperatura puede descender por debajo del punto de congelación, vaciar en cualquier caso la caldera y los tubos de circulación del agua.

**P**



### INDICAÇÕES PARA A INSTALAÇÃO

1. Ler atentamente todas as advertências contidas no presente manual, pois as mesmas fornecem indicações importantes relativas à segurança da instalação, uso e manutenção. Conservar devidamente esta publicação para futuras consultas.
2. Este aparelho deverá ser usado apenas para a finalidade para a qual foi especificamente concebido. O construtor não pode ser considerado responsável por eventuais danos derivados de usos impróprios, errados ou irracionais.
3. Depois de se ter retirado a embalagem, controlar que o aparelho se encontre em perfeitas condições. Os vários componentes da embalagem (sacos de plástico, esferovit, agrafes, etc.) devem ser mantidos fora do alcance das crianças dado que se podem demonstrar muito perigosos.
4. Antes de conectar o aparelho, controlar que os dados da placa correspondam a los de la red de distribución eléctrica e hídrica.
5. A máquina de café deve ser apoiada sobre uma superfície plana e estável e a uma distância de 20 mm das paredes e da superfície de apoio. Além disso, tem de ser instalada, considerando que a superfície de apoio mais alta (aquecedor de chávenas) se encontra a uma altura não inferior a 1,5 metros.  
A temperatura ambiente tem de ser entre os 0 e os 32°C.
6. As ligações de alimentação (energia eléctrica e água) e a descarga da água dotada de sifão deverão ficar muito próximas; é necessário ainda prever uma superfície de apoio para os acessórios.
7. É necessário montar na instalação um interruptor omnipolar com uma distância entre os contactos igual ou superior a 3 mm, uma protecção da corrente de dispersão com valor igual a 30 mA.
8. A segurança eléctrica deste aparelho é garantida apenas quando o mesmo se encontra devidamente ligado a uma eficaz instalação de terra, tal como previsto pelas vigentes normas de segurança. É necessário verificar esta importante norma de segurança e, no caso de dúvida, solicitar um controle da instalação por parte de pessoal técnico profissionalmente qualificado. O fabricante não pode ser considerado responsável por eventuais danos causados pela falta de ligação à terra da instalação.
9. Em geral é desaconselhável o emprego de adaptadores, tomadas múltiplas e extensões. No caso em que o seu uso fosse indispensável é necessário usar apenas adaptadores simples ou múltiplos e extensões conformes às vigentes normas de segurança, prestando no entanto atenção a não ultrapassar o limite máximo de capacidade do valor da corrente, marcado sobre o adaptador simples ou sobre as extensões e aquele de potência máxima marcado sobre o adaptador múltiplo.
10. A fim de evitar sobreaquecimentos perigosos, recomenda-se utilizar o cabo eléctrico de alimentação completamente desenrolado.
11. Para proteger as características de funcionalidade e de segurança, recomenda-se não deixar a máquina de café exposta aos agentes atmosféricos (chuva, sol, gelo).
12. Não instalar em locais (cozinha) em que a limpeza seja realizada mediante jactos de água. Seja como for, evitar limpar o aparelho com jactos de água.
13. Não obstruir as aberturas ou canais de ventilação e de dispersão do calor.
14. No caso de desarranjo do cabo de alimentação, o mesmo deve ser substituído apenas pela assistência técnica autorizada.
15. Se a máquina for armazenada em locais em que a temperatura possa baixar para além do ponto de congelação, esvaziar a caldeira e os tubos de circulação da água.

## Installazione - Installation - Installation - Installation - Instalación - Instalação

Dati tecnici **Vedere la targa dati della macchina**  
 Technical data **See the machine's nameplate**  
 Données techniques **Voire la plaque signalétique de la machine**  
 Technische Daten **Siehe Datenschild der Maschine**  
 Datos técnicos **Ver la placa con los datos de la máquina**  
 Datos técnicos **Ver a placa das características da máquina**

RUMOROSITA'	L'apparecchio non supera i 70 dB
NOISE	The equipment does not exceed 70dB
BRUIT	L'appareil ne dépasse pas 70 dB
GERÄUSCH	Das Gerät überschreitet 70 dB nicht
RUIDOSIDAD	El aparato no supera los 70 dB
RUIDO	O aparelho não ultrapassa os 70 dB

**FAEMA** BINASCO (MI) ITALY

MODEL: \_\_\_\_\_  
 \_\_\_\_\_  
 \_\_\_\_\_  
 \_\_\_\_\_

Date: MM-YYYY      Nr.: 1234567  
 CODE: .....

**INTERRUTTORE:** Onnipolare con distanza di apertura contatti 3 mm  
 Protezione da corrente di dispersione con valore pari a 30 mA

**SWITCH:** Omnipolar switch with 3 mm contact opening 30 mA dispersion-current protection

**INTERRUPTEUR:** Omnipolaire, avec distance d'ouverture des contacts égale à 3 mm  
 Protection contre la dispersion de courant ayant une valeur égale à 30 mA

**SCHALTER:** Allpoliger Schalter mit Kontaktöffnungsweite von 3 mm  
 Fehlerstromschutz für 30 mA

**INTERRUPTOR:** Omnipolar con distancia de apertura contactos 3 mm  
 Protección contra corriente de dispersion con valor de 30 mA

**INTERRUPTOR:** Omnipolar com uma distância de abertura dos contatos de 3 mm  
 Protecção da corrente de dispersão com valor igual a 30 mA

- IMPIANTO CLIENTE
- CONNECTIONS WHICH MUST BE PREPARED BY THE CUSTOMER
- BRANCHEMENTS, QUI DOIVENT ÊTRE PRÉPARÉS PAR LE CLIENT
- VOM KUNDEN ZU ERSTELLENDEN ANSCHLÜSSE
- CONEXIONES, QUE DEBEN SER PREPARADAS POR EL CLIENTE
- CONEXÕES QUE DEVEM SER PREPARADAS PELO CLIENTE



**Rubinetto alimentazione acqua**  
**Water feeding tap**  
**Robinet alimentation eau**  
**Wasserversorgungshahn**  
**Torneira alimentação água**  
**Torneira alimentação água**

PRESSIONE MAX. RETE  
 WATER MAINS MAX. PRESSURE  
 PRESSION MAX. EAU DE VILLE  
 MAX. DRUCK DER WASSERLEITUNG  
 PRESION MAX. RED  
 PRESSÃO MAX. REDE

**6 bar - 0,6 MPa**

(per pressioni più alte installare un riduttore di pressione)

(for pressure beyond this value, install a pressure reducer)

(pour pression plus haute installer un détendeur)

(bei höheren Druckwerten Druckreduzierer erforderlich)

(para presiones más altas instalar un reductor de presión)

(para pressões mais elevadas instalar um redutor de pressão)

MESSA A TERRA: OBBLIGATORIA  
 GROUNDING: COMPULSORY  
 MISE A TERRE: OBLIGATOIRE  
 ERDUNG: VORGESCHRIEBEN  
 PUESTA A TIERRA: OBLIGATORIA  
 INSTALAÇÃO DE TERRA: OBRIGATORIA

SCARICO A PAVIMENTO  
 DRAIN  
 VIDANGE DU LOCAL  
 BODENABFLUSS  
 DESCARGA  
 DESCARGA

Min. Ø 50 mm.



## Installazione - Installation - Installation - Installation - Instalación - Instalação

### I COLLEGAMENTI IDRAULICI

Posizionare l'apparecchio in perfetto piano orizzontale agendo sui piedini, indi fissarli.

Eseguire i collegamenti idraulici come indicato in figura 1, rispettando le vigenti norme di sicurezza idraulica del paese di installazione.

Ricordarsi di interporre nelle giunzioni tra tubi e raccordi le relative guarnizioni.

Se la durezza dell'acqua è superiore ai 8°F, si consiglia l'installazione di un appropriato addolcitore ed eventualmente di una valvola di non ritorno a monte dello stesso; per la scelta attenersi alle norme locali vigenti in materia di igiene. Nel caso si dovesse alimentare la macchina con acqua di durezza superiore agli 8°F, per il buon funzionamento della stessa, occorre applicare un piano di manutenzione specifico. La quantità di cloro contenuta nell'acqua non deve superare i 100 mg/l; in caso contrario provvedere all'installazione di appropriati dispositivi.

N.B.: nel caso la pressione di rete possa salire oltre 6 bar, prima dell'addolcitore installare un riduttore di pressione tarato a 2÷3 bar.

**Tubo di scarico:** mettere un'estremità del tubo di scarico in un pozzetto dotato di sifone per l'ispezione e la pulizia.

**IMPORTANTE:** il tubo di scarico, nelle curve, **NON** deve avere un andamento come indicato in figura 2; in tal caso operare come indicato in figura 3.

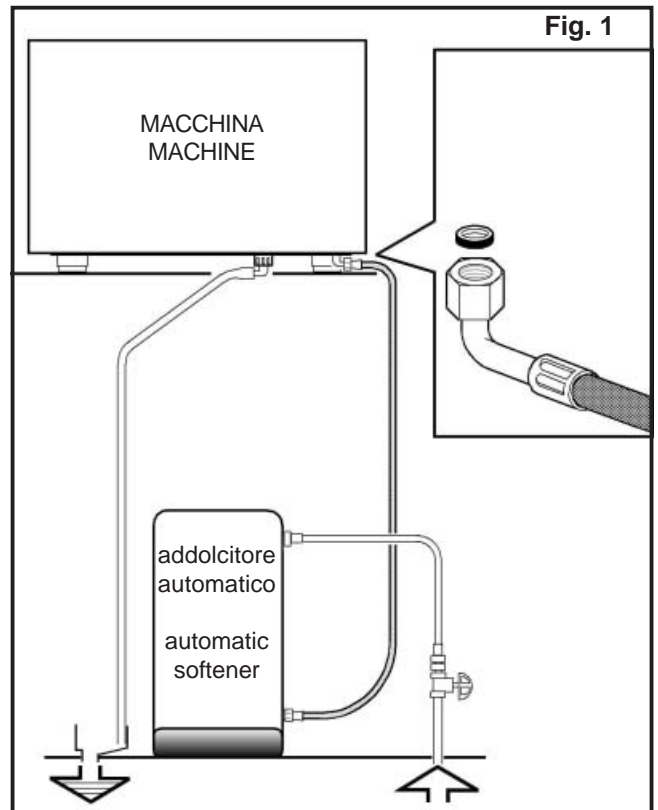

### GB HYDRAULIC CONNECTION

Place the machine on a perfectly levelled surface, adjusting and then fixing the feet in place.

Make the hydraulic connections as per Figure 1, in conformity to the hydraulics safety laws in force in the country of installation.

Remember to put the relevant washer in the junctions between the tubes and the connectors.

If water hardness is higher than 8° F, it is advised to install a water softener and, possibly, a non return valve before it. For the choice, please comply with local hygiene laws.

If the machine is fed with water with a hardness of over 8° F, a specific maintenance plan must be implemented to ensure correct functioning of the machine.

The amount of chlorine in the water must not exceed 100 mg/l; otherwisw, install the appropriate devices.

N.B.: if the main pressure could rise above 6 bar, install a pressure reducer calibrated at 2÷3 bar before the softener.

**Drain tube:** place one end of the drain tube into a tank with a siphon for inspection and cleaning.

**IMPORTANT:** The disposal tube must **NOT** bend as in Figure 2. See Figure 3 for correct positioning.

**ATTENTION:** This equipment is to be installed to comply with the applicable federal, state or local plumbing codes having jurisdiction.

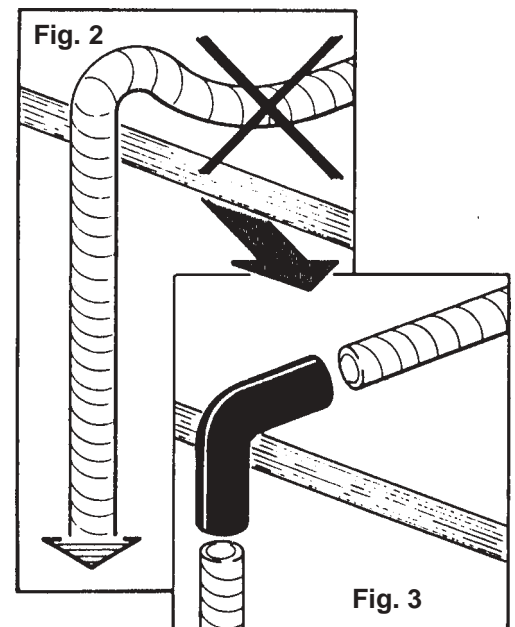

## Installazione - Installation - Installation - Installation - Instalación - Instalação

### F CONNECTION HYDRAULIQUE

Positionner l'appareil parfaitement horizontal en agissant sur les pieds.

Faire les connexions hydrauliques comme indiqué dans la fig. 1, respectant les normes en vigueur de sécurité hydraulique du pays d'installation.

Se rappeler d'interposer dans les jonctions entre tuyaux et raccords les joints relatifs.

Si la dureté de l'eau est supérieure à 8°F, il est conseillé d'installer un adoucisseur approprié et éventuellement d'un clapet de non retour en amont de celui-ci; pour faire son choix, se référer aux normes locales en vigueur en matière d'hygiène.

Au cas où l'alimentation de la machine avec une eau de dureté supérieure à 8°F serait nécessaire, pour le bon fonctionnement de cette dernière, appliquer un plan d'entretien spécifique.

La quantité de chlore contenue dans l'eau ne doit pas dépasser 100 mg/l; en cas contraire veiller à l'installation de dispositifs appropriés.

N.B.: dans les cas où la pression de réseau puisse monter à plus de 6 bar installer, avant de l'adoucisseur, un réducteur de pression taré à 2÷3 bar.

**Tube de décharge:** placer une extrémité du tube de décharge dans une fosse dotée de siphon pour l'inspection et le nettoyage.

**IMPORTANT :** dans les tournants, le tube de décharge NE DOIT PAS apparaître comme sur la Fig. 2; dans ce cas, procéder comme indiqué sur la Fig. 3.

### D WASSERANSCHLÜSSE

Die Maschine muß vollkommen waagrecht stehen (zu diesem Zweck sind die entsprechend verstellbaren Füße zu verwenden); dann sind die Füße mit den Sperrmuttern zu sichern.

Die Wasseranschlüsse sind nach Abbildung 1 anzubringen, unter Beachtung der am Aufstellungsort des Gerätes geltenden einschlägigen Bestimmungen zur Betriebssicherheit von hydraulischen Anlagen.

Es ist daran zu erinnern, dass Dichtungen zwischen Rohre und entsprechende Anschlussstücke zu fügen sind.

Bei einer Wasserhärte über 8°F wird geraten, einen Wasserenthärter sowie ggf. vor dem Wasserenthärter ein Rückschlagventil zu installieren. Halten Sie sich bei der Wahl des zu installierenden Systems an die am Aufstellungsort der Maschine in Sachen der Hygiene geltenden Bestimmungen.

Sollte die Maschine mit Wasser mit einer Härte über 8°F versorgt werden müssen, so muß, um die vorschriftsmäßige Funktion der Maschine zu gewährleisten, ein spezifischer Wartungsplan eingehalten werden.

Der Chlorgehalt des Wassers darf 100 mg/l nicht überschreiten; anderenfalls muß ein geeignetes Klärsystem installiert werden.

ANMERKUNG: Falls der Netzwasserdruck über 6 bar steigen könnte, ist vor dem Enthärter ein auf 2 bis 3 bar tarierter Druckreduzierer zu installieren.

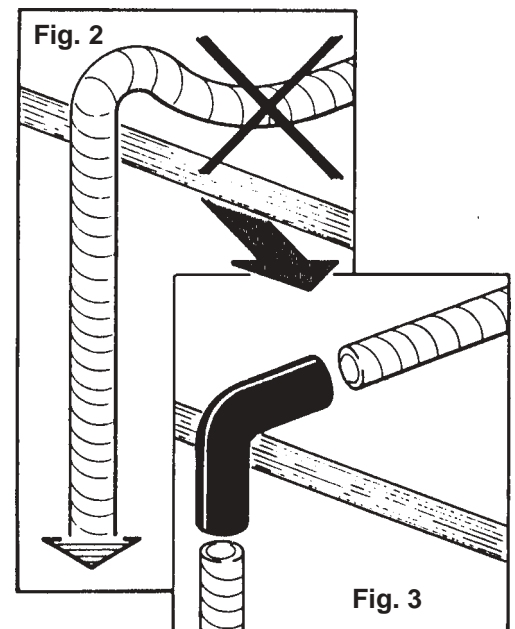
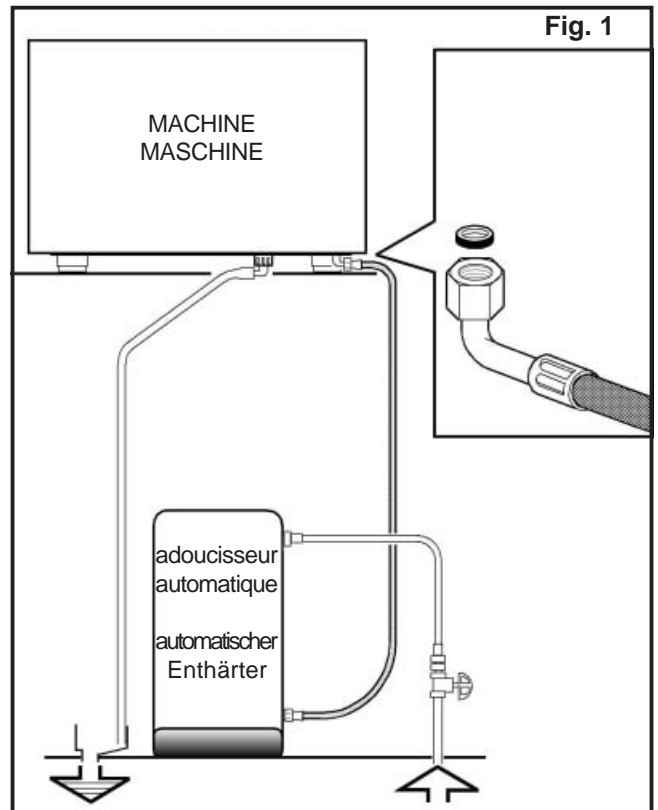

**Ablaßschlauch:** Positionieren Sie ein Ende des Schlauchs in einem Ablauf, der mit Siphon zur Inspektion und Reinigung ausgestattet sein muss.

**WICHTIG:** Der Ablaßschlauch darf nicht wie in Abb. 2 gezeigt gekrümmt werden; setzen Sie bei Krümmungen ein entsprechend gebogenes Rohr ein (Abb. 3).



## Installazione - Installation - Installation - Installation - Instalación - Instalação

### E CONEXIONES HIDRAULICAS

Posicionar el aparato en un perfecto plano horizontal, obrando sobre los piés, luego fijarlos.

Efectuar las conexiones hidráulicas según lo indicado en la figura 1, respetando las vigentes normas de seguridad hidráulica del país de instalación.

Acordarse de interponer las relativas ensambladuras en los empalmes que unen los tubos a las conexiones.

Si la dureza del agua es superior a los 8°F, se aconseja la instalación de un adecuado ablandador y eventualmente de una válvula de retención antes del mismo; para la elección hay que tener en cuenta las normas locales vigentes en materia de higiene.

En el caso de que tuviese que alimentar la máquina con agua que tenga una dureza superior a los 8°F, para el buen funcionamiento de la misma, hay que aplicar un programa de mantenimiento específico.

La cantidad de cloro contenida en el agua no tiene que superar los 100 mg/l; en caso contrario, hay que instalar adecuados dispositivos.

N.B.: si la presión de la red hidrica pudiese subir a más de 6 bar, instalar antes del aduador un reductor de presión, calibrado a 2÷3 bar.

**Tubo de desagüe:** meter un extremo del tubo de desagüe en un pozo equipado con sifón para la inspección y la limpieza.

**IMPORTANTE:** el tubo de desagüe, en las curvas, **NO** tiene que tener un recorrido como se indica en la figura 2; en dicho caso, realizar la operación descrita en la figura 3.

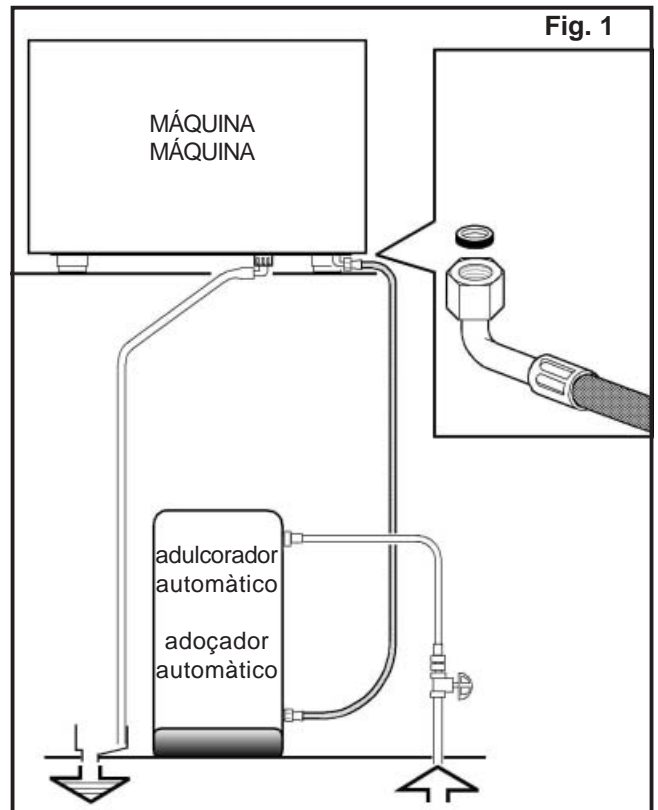

### P LIGAÇÕES HIDRÁULICAS

Colocar o aparelho em perfeita posição horizontal regulando mediante os pés e depois fixá-los.

Proceder às ligações hidráulicas tal como ilustrado na figura 1, respeitando as normas de segurança hidráulica em vigor no país de instalação.

Não esquecer de interpor nas ligações entre os tubos e os acessórios as respectivas juntas.

Se a dureza da água for superior a 8°F, aconselha-se a instalação de um adoçante apropriado e eventualmente de uma válvula anti-regresso a colocar na parte superior do mesmo; para a escolha respeitar as normas locais em vigor em matéria de higiene.

Caso se tenha de alimentar a máquina com água de dureza superior aos 8°F, para um bom funcionamento da mesma, é necessário aplicar um plano de manutenção específico.

A quantidade de cloro contida na água não pode ultrapassar os 100 mg/l; em caso contrário proceder à instalação de dispositivos específicos.

A quantidade de cloro existente na água não deve superar os 100 mg/l; caso contrário proceder à instalação de dispositivos apropriados.

N.B.: no caso em que a pressão de rede possa subir além de 6 bar, antes do adoçador instalar um reductor de pressão tarado a 2÷3 bar.

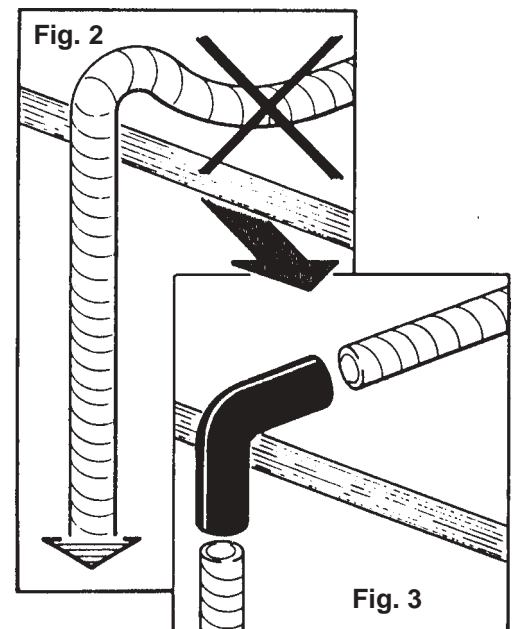

**Tubo de descarga:** colocar a extremidade do tubo de descarga num poço dotado de sifão para a inspeção e a limpeza.

**IMPORTANTE:** o tubo de descarga, nas curvas, **NÃO** deve ter um desvio, conforme indicado na figura 2; neste caso actuar conforme indicado na figura 3.

## Installazione - Installation - Installation - Installation - Instalación - Instalação

### I COLLEGAMENTO ELETTRICO

- Prima del collegamento verificare se l'impianto elettrico predisposto a cura del Cliente rispetta le norme vigenti e se ha la messa a terra regolamentare. Ricordiamo che il Gruppo Cimbali Spa non risponde dei danni provocati da un non corretto collegamento elettrico. Ricordiamo inoltre la responsabilità dell'installatore nel caso di danni.
- Controllare inoltre:
  - il tipo di collegamento indicato sulla etichetta posta sul cavo di alimentazione
  - la tensione deve corrispondere a quella indicata sulla targa dati posta sul coperchio scatola.
- Le macchine sono predisposte per un collegamento: normalmente Y (fig. 1)
- Nel caso si debba modificare il collegamento da (Y) a ( $\Delta$ ) occorre intervenire seguendo gli schemi indicati in figura 2.
- Le macchine con collegamento monofase sono con cablaggio specifico.

### GB ELECTRIC CONNECTION

- Before making the connection, verify that the electric wiring prepared by the customer follows the current regulations and that it has been earthed according to regulations. Remember that Gruppo Cimbali Spa is not responsible for damages due to incorrect electrical connections and, furthermore, that the installer is responsible in case of damage.
- Besides the above, check:
  - the type of connection indicated on the label found on the power cable.
  - that the voltage corresponds to that indicated on the nameplate data found on the box cover.
- The machines are planned for these connections: normally Y (fig. 1).
- If the connection between (Y) and ( $\Delta$ ) needs to be changed, follow the instructions in the diagrams in Figure 2.
- The machines with single phase connection have a special wiring system.

### F BRANCHEMENT ELECTRIQUE

- Avant de brancher, vérifier que l'installation électrique prédisposée par le client respecte les normes en vigueur et que la mise à terre soit réglementaire. Rappelons que Gruppo Cimbali Spa ne répond pas des dommages provoqués par un mauvais branchement électrique. Rappelons en outre la responsabilité de l'installateur en cas de dégâts.
- Contrôler également:
  - le type de branchement indiqué sur l'étiquette apposée sur le câble d'alimentation.
  - la tension doit correspondre à celle qui est indiquée sur la plaquette de données apposée sur le couvercle de la boîte.
- Les machines sont prédisposées pour un branchement: normalement Y.
- Au cas où une modification du raccordement monophasé de (Y) avec ( $\Delta$ ) serait nécessaire, intervenir en suivant les schémas indiqués dans la figure 2.
- Les machines à raccordement monophasé sont dotées d'un câblage spécifique.

3NPE

Fig. 1

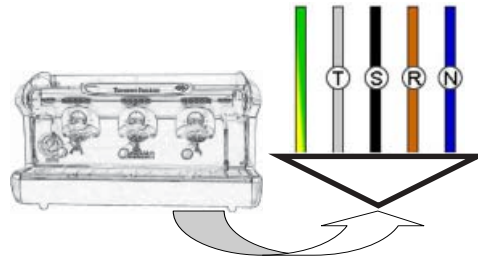

3PE

Fig. 2

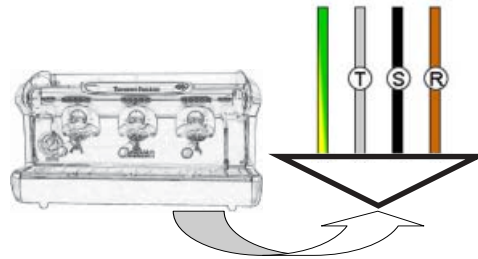

1PE

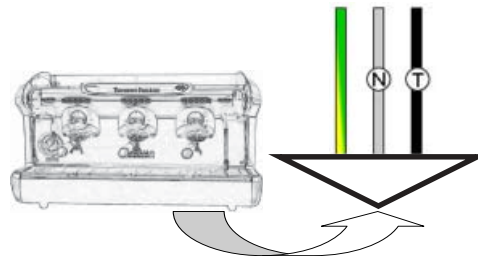

Colore cavi - Wires colour - Couleur cables

*Macchine con collegamento trifase*  
*Machines with three-phase connection*  
*Machines à raccordement triphasé*

**T** Grigio (Nero) - Grey (Black) - Gris (Noir)  
**S** Nero - Black - Noir  
**R** Marrone - Brown - Brun  
**N** Azzurro - Blue - Bleu

*Macchine con collegamento monofase*  
*Machines with single phase connection*  
*Machines à raccordement monophasé*

**N** Bianco - White - Blanc  
**T** Nero - Black - Noir

1

**N** Azzurro - Blue - Bleu  
**T** Marrone - Brown - Brun

2

## Installazione - Installation - Installation - Installation - Instalación - Instalação

### D STROMANSCHLUSS

- Überprüfen Sie vor der Erstellung des Stromanschlusses, ob die vom Kunden vorbereitete Elektroanlage den einschlägigen Bestimmungen entspricht und über eine vorschriftsmäßige Erdung verfügt. Wir weisen erneut darauf hin, daß die Firma Gruppo Cimbali Spa keinerlei Haftung für Schäden übernimmt, die durch eine unsachgemäße Elektroanlage verursacht werden. Wir erinnern außerdem an die Haftbarkeit des Installateurs für eventuell entstehende Schäden.
- Ferner folgendes kontrollieren:
  - die am Stromkabel angegebene Anschlußart
  - ob die Netzspannung mit den Angaben des Typenschildes übereinstimmt, das auf dem Gehäusedeckel des Geräts angebracht ist.
- Die Geräte sind für folgende Anschlußarten vorgesehen: Normalerweise Stern-Verbindung ( Y ).
- Gehen Sie zur Modifikation der Verbindung zwischen (Y) und ( $\Delta$ ) wie in der Abbildung 2 dargestellt vor.
- Die Maschinen mit einphasigem Anschluß haben eine spezifische Verdrahtung.

### E CONEXION ELECTRICA

- Antes de conectarse, verificar si la instalación eléctrica efectuada por el cliente está conforme con las normas vigentes y si la puesta a tierra es regulamentar. Hacemos presente que el Gruppo Cimbali Spa no responde de los daños causados por una instalación eléctrica defectuosa. Recordamos además la responsabilidad del instalador, en el caso de que se verificasen daños.
- Además hay que controlar:
  - o tipo de ligação indicado na etiqueta colocada sobre o cabo de alimentação
  - la tensión tiene que corresponder a la indicada en la placa con los datos situada sobre la tapa del contenido.
- Las máquinas están ya predispuestas para las siguientes conexiones: normalmente Y.
- En el caso de que se tenga que modificar la conexión de (Y) a ( $\Delta$ ), hay que intervenir siguiendo los esquemas indicados en la figura 2.
- Las máquinas con conexión monofásica tienen un cableado específico.

### P LIGAÇÃO ELÉCTRICA

- Antes da ligação verificar se o equipamento eléctrico preparado pelo Cliente respeita as normas em vigor e tem a instalação à terra regulamentar. Recordamos que o Gruppo Cimbali Spa não responde pelos danos provocados por uma ligação eléctrica
- Verificar ainda:
  - el tipo de conexión indicado en la etiqueta situada en el cable de alimentación.
  - a tensão deve corresponder àquela indicada sobre a placa dos dados colocada sobre a tampa da caixa.
- As máquinas são preparadas para uma ligação: geralmente Y (fig. 1).
- No caso de se ter que modificar a ligação de (Y) para ( $\Delta$ ) é necessário intervir seguindo os esquemas indicados na figura 2.
- As máquinas com ligação mono-fásica têm uma cablagem específica.

3NPE

Fig. 1

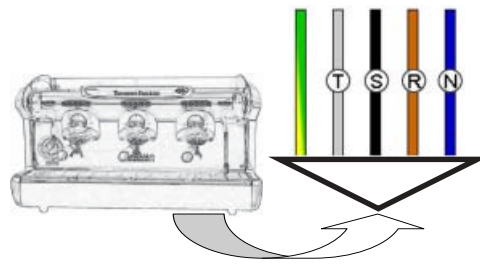

3PE

Fig. 2

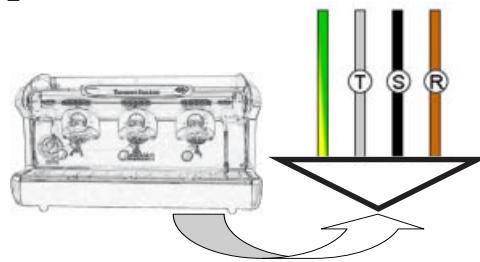

1PE

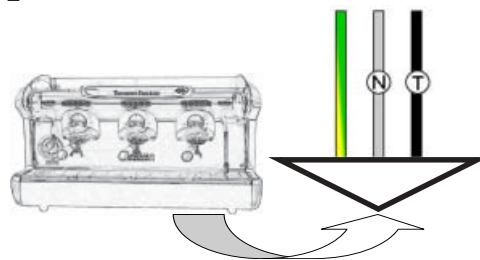

Farbe der Drähte - Color cables - Cor cabos

*Maschinen mit dreiphasig Anschluß*

*Máquinas con conexión trifásica*

*Máquinas com ligação trifásica*

**T** Grau (Schwarz) - Gris (Negro) - Cinza (Preto)

**S** Schwarz - Negro - Preto

**R** Braun - Maròn - Marron

**N** Blau - Azül - Azul

*Maschinen mit einphasigem Anschluß*

*Máquinas con conexión monofásica*

*Máquinas com ligação mono-fásica*

**N** Weiß - Blanco - Branco

**T** Schwarz - Negro - Preto

①

**N** Blau - Azül - Azul

**T** Braun - Maròn - Marron

②

## Installazione - Installation - Installation - Installation - Instalación - Instalação

### I COLLEGAMENTO EQUIPOTENZIALE

Questo collegamento previsto da alcune norme, ha la funzione di evitare le differenze di livello di potenziale elettrico, tra le masse delle apparecchiature installate nello stesso locale.

Questo apparecchio è predisposto con un morsetto posto sotto il basamento per il collegamento di un conduttore esterno equipotenziale.

Terminata l'installazione è **NECESSARIO** eseguire questo tipo di collegamento:

- usare un conduttore avente una sezione nominale in conformità con le norme vigenti.
- collegare al morsetto (vedi figura) e l'altro capo alle masse delle apparecchiature adiacenti.

La mancata attuazione di questa norma di sicurezza scagiona il costruttore da ogni responsabilità per guasti o danni che possano essere causati a persone o cose.

**N.B. NON COLLEGARE ALLA MESSA A TERRA DELL'IMPIANTO DI DISTRIBUZIONE ELETTRICA IN QUANTO IL CONDUTTORE DI MESSA A TERRA IN UN CAVO DI ALIMENTAZIONE NON VIENE CONSIDERATO UN CONDUTTORE DI COLLEGAMENTO EQUIPOTENZIALE.**

### GB POTENTIAL-EQUALIZING CONNECTION

This connection, which is the one called for by several norms, avoids electrical potential differences building up between any equipment that may be installed in the same room. There is a terminal clip on the under side of the base of the machine to which an external potential-equalizing wire should be connected.

This connection is **ABSOLUTELY NECESSARY** and must be made right after the machine is installed.

- Use a wire whose cross-sectional area conforms to the existing norms.
- Make the terminal connection (see diagram) and then connect the other end to the ground connections located on the adjacent equipment.

Failure to do observe these safety precautions will exempt the manufacturer from any responsibility as regards damage caused to persons or property.

**NOTE: DO NOT CONNECT THE MACHINE'S TERMINAL CLIP TO THE MAINS GROUND TERMINAL BECAUSE THE GROUND TERMINAL OF ANY MAIN SOURCE OF ELECTRICAL POWER IS NOT CONSIDERED TO BE A POTENTIAL-EQUALIZING CONNECTION.**

### F CONNEXION EQUIPOTENTIELLE

Ce raccordement, prévu par certaines normes, permet d'éviter les différences de niveau de potentiel électrique entre les masses des appareils installés dans une même pièce. Cet appareil poss. de sous sa base d'une borne servant pour la connexion d'un conducteur externe équipotentiel.

Une fois terminée l'installation, il est **NECESSAIRE** d'effectuer ce type de connexion:

- utiliser un conducteur ayant une section nominale conforme aux normes en vigueur;
- relier à la borne (voir figure) et l'autre extrémité aux masses des appareils adjacents.

Le non-respect de cette norme de sécurité libère le fabricant de toute responsabilité en cas de panne ou de dommages causés aux personnes ou aux choses.

**N.B.: NE PAS RELIER A LA TERRE DE L'INSTALLATION DE DISTRIBUTION ELECTRIQUE CAR LE CONDUCTEUR DE TERRE D'UN CABLE D'ALIMENTATION N'EST PAS CONSIDERE COMME ETANT UN CONDUCTEUR DE CONNEXION EQUIPOTENTIEL.**

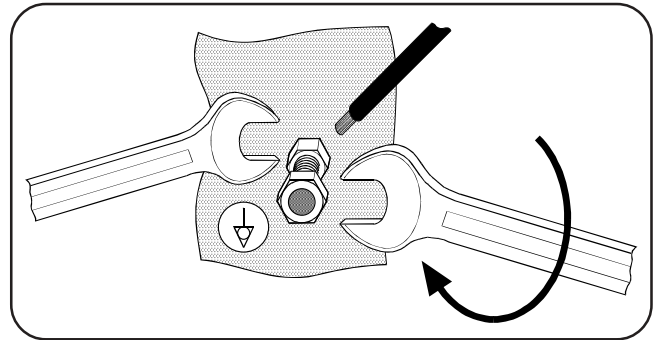

### D STROMANSCHLUSS MIT POTENTIALAUSGLEICH

Dieses Gerät ist unter dem Untergestell mit einer Anschlußklemme versehen, die mit einem externen Stromausgleichsleiter zu verbinden ist.

Nach der Installation **MUSS** der Stromanschluß wie folgt vorgenommen werden:

- Einen Leiter verwenden, dessen Nennquerschnitt den einschlägigen Unfallschutzbestimmungen entspricht;
- ihn wie in der Abbildung gezeigt an die Klemme anschließen.

Bei Nichtbeachtung dieses Sicherheitshinweises schließt der Hersteller jedwede Haftungsansprüche für Personen- oder Sachschäden aus.

**HINWEIS: NICHT AN DIE ERDUNG DER STROMZUFUHRANLAGE ANSCHLIESSEN, DA DER ERDUNGSLEITER EINES SPEISUNGSKABELS NICHT ALS AUSGLEICHSLEITER GELTEN KANN.**

### E CONEXION EQUIPOTENCIAL

Este aparato está preajustado con un borne ubicado debajo de la base para la conexión de un conductor externo equipotencial.

Una vez terminada la instalación es **NECESARIO** efectuar este tipo de conexión:

- usar un conductor con una sección nominal conforme con las normas vigentes.
- conectar al borne (ver figura).

La falta de respeto de esta norma de seguridad exime al fabricante de toda responsabilidad por desperfectos o daños que puedan ser causados a personas o cosas.

**NOTA: NO CONECTAR CON LA PUESTA A TIERRA DE LA INSTALACION DE DISTRIBUCION ELECTRICA DADO QUE EL CONDUCUTOR DE PUESTA A TIERRA EN UN CABLE DE ALIMENTACION NO ES CONSIDERADO UN CONDUCUTOR DE CONEXION EQUIPOTENCIAL.**

### P LIGAÇÃO EQÜIPOTENCIAL

Este aparelho está equipado com um borne, colocado sob a sua base, para a ligação a um condutor externo equipotencial.

Uma vez terminada a instalação é **NECESSÁRIO** efectuar este tipo de ligação:

- usar um condutor com uma secção nominal em conformidade com as normas vigentes;
- ligar o borne, ver a figura.

A falta de cumprimento desta norma de segurança alivia o fabricante de qualquer responsabilidade por avarias ou danos que poderiam ser causados a pessoas ou bens.

**NOTA: NÃO LIGAR À LIGAÇÃO DE TERRA DA INSTALAÇÃO DE DISTRIBUIÇÃO ELÉCTRICA ENQUANTO O CONDUTOR DE LIGAÇÃO DE TERRA NÃO É CONSIDERADO UM CONDUTOR DE LIGAÇÃO EQÜIPOTENCIAL.**



## Installazione - Installation - Installation - Installation - Instalación - Instalação

### I COLLEGAMENTO DEL GAS (solo per modelli con + GAS)

Tenendo presente i regolamenti locali, il collegamento alla tubazione del gas può essere fatto sia con tubo rigido che con tubo flessibile vedi figura.

Per l'installazione con tubo flessibile:

- In dotazione vengono forniti 2 raccordi portagomma per favorire il montaggio di tubi, rispondenti alle normative di sicurezza, con diverse dimensioni, in funzione del tipo di gas utilizzato.
- Bloccare il tubo sui raccordi portagomma con fascette rispondenti alle normative di sicurezza.

Una volta effettuato il collegamento, verificare e individuare le eventuali fughe con soluzione saponosa ed eliminarle; rammentiamo le responsabilità dell'installatore nel caso di imperfetto funzionamento dell'impianto.

#### Sostituzione iniettori

La macchina è predisposta per l'alimentazione con GPL (gas liquido) ossia ha l'iniettore e l'autoregolatore montato e tarato in fabbrica per tale tipo di gas. Se il gas è di tipo diverso, occorre cambiare l'iniettore " A " montato con quello adatto;

- sganciare la molletta blocca bruciatore.
- far scorrere il bruciatore dopo aver allentato la vite " B ".
- sostituire l'iniettore con quello adatto vedere tabella.
- riposizionare il tutto ricordandosi di riagganciare la molletta blocca bruciatore.

### GB GAS CONNECTION (only for models with + GAS)

Keeping local regulations in mind, the connection to gas tubing can be done with either a rigid tube or a flexible tube, see Figure.

For installation with flexible tube:

- Two hose-adaptor connectors, with differing dimensions according to the type of gas used, are supplied for the installation of the tube. The connectors conform to safety norms.
- Block the tube on the hose-adaptor connectors with clamps that conform to the safety norms.

Once the connection is made, check for possible gas leaks with a soapy solution and eliminate them. We remind you that any improper functioning of the installation is the responsibility of the installer.

#### Substitute injectors

The machine is prepared for the use of GPL (liquid propane gas), that is, it has an injector and self-adjuster installed and calibrated in the factory for that type of gas. If the gas is of a different type, the injector " A " must be replaced with a suitable injector;

- disconnect the burner block spring.
- let the burner slide after having loosened screw " B ".
- replace the injector with the suitable one. See table.
- reposition the parts, remembering to reconnect the burner block spring.

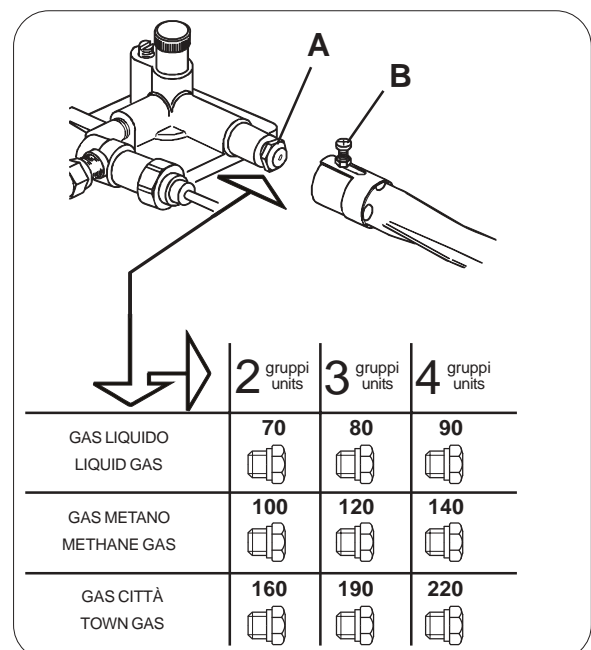
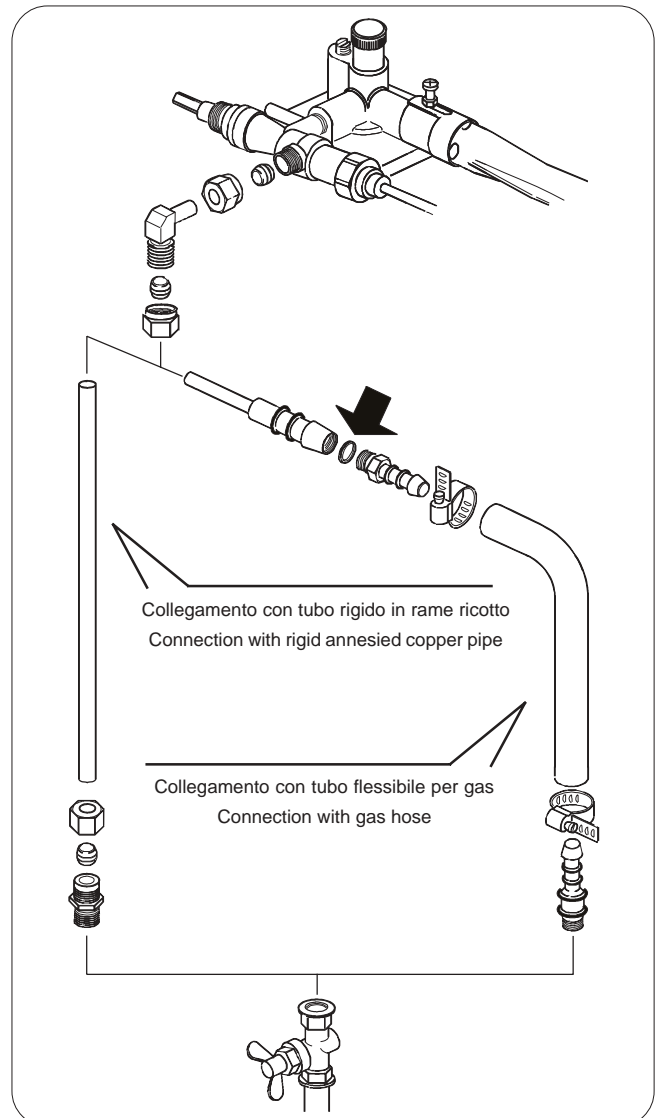

## Installazione - Installation - Installation - Installation - Instalación - Instalação

### F BRANCHEMENT DU GAZ (seulement pour modèles avec + GAS)

Dans le respect des réglementations locales, le branchement aux conduites de gaz peut se faire aussi bien avec un tuyau rigide qu'avec un tuyau flexible (voir figure).

Pour l'installation avec un tuyau flexible:

- 2 raccords porte-caoutchouc sont livrés en dotation pour faciliter le montage de tuyaux, répondant aux normes de sécurité, avec différentes dimensions, en fonction du type de gaz utilisé.
- Bloquer le tuyau sur les raccords porte-caoutchouc avec des colliers aux normes de sécurité.

Une fois le branchement effectué, vérifier et déceler les fuites éventuelles avec une solution savonneuse, et les éliminer; nous rappelons la responsabilité de l'installateur en cas de fonctionnement imparfait de l'installation.

#### Remplacement injecteurs

La machine est prédisposée pour l'alimentation au GPL (gaz liquide), c'est-à-dire que l'injecteur et l'autorégulateur sont montés et tarés en usine pour ce type de gaz. Si le gaz est d'un autre type, il faut remplacer l'injecteur déjà monté par celui qui convient;

- détacher la pince qui bloque le brûleur.
- faire coulisser le brûleur après avoir dévissé la vis " B ".
- remplacer l'injecteur par celui qui est adapté (voir tableau).
- repositionner le tout sans oublier de raccrocher la pince qui bloque le brûleur.

### D GASANSCHLUSS (ausschl. für modelle + GAS)

Je nach örtlich geltenden Bestimmungen kann für den Anschluß an die Gasleitung sowohl ein Rohr als auch ein Schlauch verwendet werden (siehe Abbildung).

- Unter den mitgelieferten Extrateilen befinden sich 2 Schlauchhalterungsanschlüsse zur leichteren Anbringung der Schläuche, die den Sicherheitsbestimmungen entsprechen und in zwei verschiedenen Größen ausgeführt sind (auszuwählen je nach gegebener Gasart).
- Den Schlauch an den Schlauchhalterungsanschlüssen mit Schlauchschellen sichern, die den Sicherheitsbestimmungen entsprechen.

Nach Erstellung des Gasanschlusses die Leitungen mit Hilfe einer Seifenlösung auf Austritte überprüfen und gegebenenfalls beseitigen. Wir erinnern, daß für eine unsachgemäße Funktionstüchtigkeit der Anlage der Installateur haftbar gemacht wird

#### Ersetzung der Einspritzventile

Das Gerät ist vorbereitet für die Versorgung mit GPL-Gas (Flüssiggas), d.h. das Einspritz- und das Selbstregelventil sind im Werk für diese Gasart ausgewählt und tariert worden. Sollte das Gerät mit einer anderen Gasart versorgt werden, ist das eingebaute Einspritzventil " A " mit dem jeweils erforderlichen zu ersetzen;

- Die Sperrfeder des Brenners aushaken.
- nach Lockern der Schraube " B " den Brenner wegschieben.
- das Einspritzventil mit dem geeigneten Ventil ersetzen (siehe Tabelle).
- alle Teile in ihre vorherige Position zurückbringen und auch die Sperrfeder des Brenners wieder einhaken.

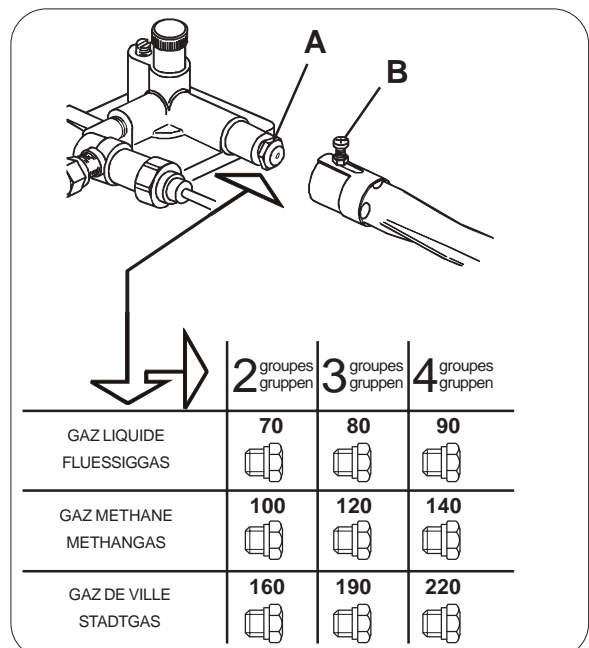
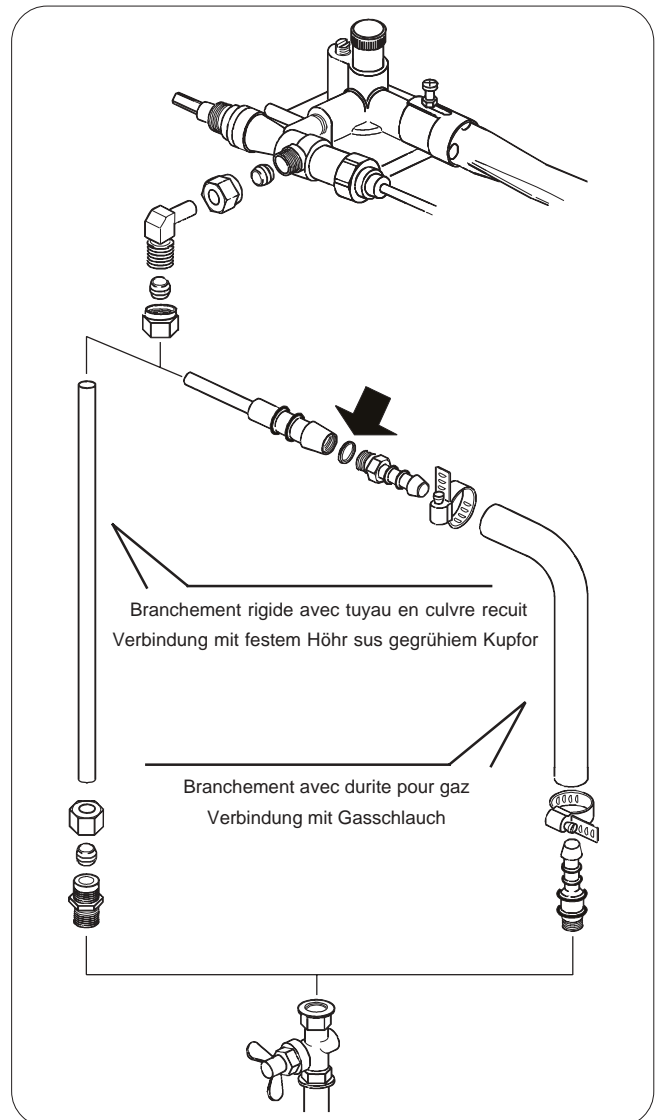



## Installazione - Installation - Installation - Installation - Instalación - Instalação

### E CONEXION DEL GAS ( solo para modelos con + GAS )

Tomado en consideración los reglamentos locales, la conexión con la tubería del gas se puede efectuar sea con un tubo rígido, que con un tubo flexible, ver figura. Para la instalación con tubo flexible:

- En dotación se suministran dos empalmes portagoma que favorecen la instalación de las tuberías, conformes a las normativas de seguridad, con diferentes dimensiones, en función del tipo de gas utilizado.
- Bloquear el tubo sobre los empalmes portagoma con sbrazaderas conformes a las normativas de seguridad. Una vez que se haya efectuado la conexión, verificar e individualar eventuales fugas con solución jabonosa y eliminarlas; nos permitimo recordar la responsabilidad del instalador en el caso de funcionamiento defectuoso de la instalación.

#### Sustitucion de los inyectores

La máquina está predispuesta para su alimentación con GPL (gas líquido), o sea tiene el inyector y el autoregulator y calibrados en fábrica para dicho tipo de gas.

Si a caso el gas fuera diferente, es necesario cambiar el inyector " A " instalado, con otro idóneo:

- desenganchar la pinza que bloquea el quemador.
- hacer resbalar el quemador después de haber aflojado el tornillo " B " .
- substituir el inyector con el fabricado adrede (ver prospecto).
- posicionar de nuevo todas las piezas acordandose de enganchar nuevamente le abrazadera que bloquea el quemador.

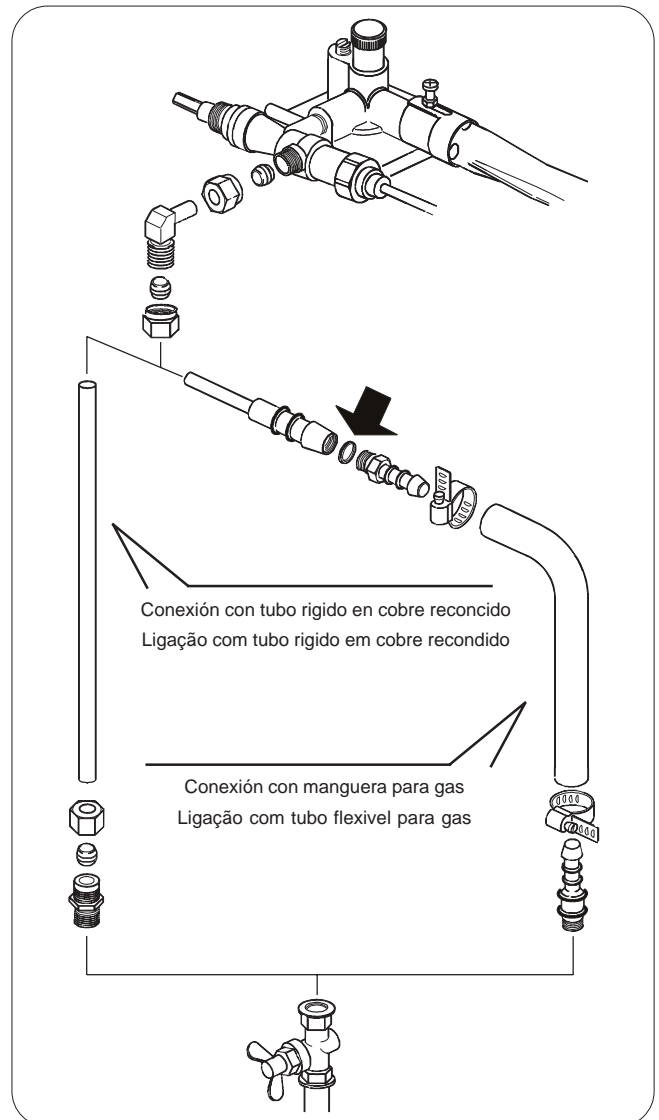

### P LIGAÇÃO DO GÁS ( apenas para modelos con + GAS )

Respeitando as normas internacionais de segurança, a ligação do gás pode ser feita quer com tubo rígido quer com tubo flexível (ver figura).

No caso de instalação com tubo flexível:

- Em dotação são fornecidos 2 ligações para borracha a fim de favorecer a montagem de tubos, as quais correspondem às normas de segurança com diversas dimensões, em função do tipo de gas utilizado.
- Fixar o tubo nas ligações de borracha usando braçadeiras com parafuso correspondentes às normas de segurança. Uma vez que a ligação foi efectuada, verificar e controlar eventuais fugas de gás mediante o uso de água e sabão e eliminá-las; lembramos que no caso de imperfeito funcionamento a responsabilidade é do instalador.

#### Substituição dos injectores

A máquina encontra-se predisposta para funcionar com GPL (gás líquido) ou seja, tem o injector e o auto-regulador montados e regulados na fábrica para tal tipo de gás.

Se o gás é diferente é necessário mudar o injector " A " que se encontra montado, com aquele apropriado:

- desprender a mola de bloqueagem do queimador.
- retirar o queimador depois de ter desapertado o parafuso " B " .
- substituir o injector com aquele apropriado (ver tabela).
- montar tudo de novo não se esquecendo de montar a mola de bloqueagem do queimador.

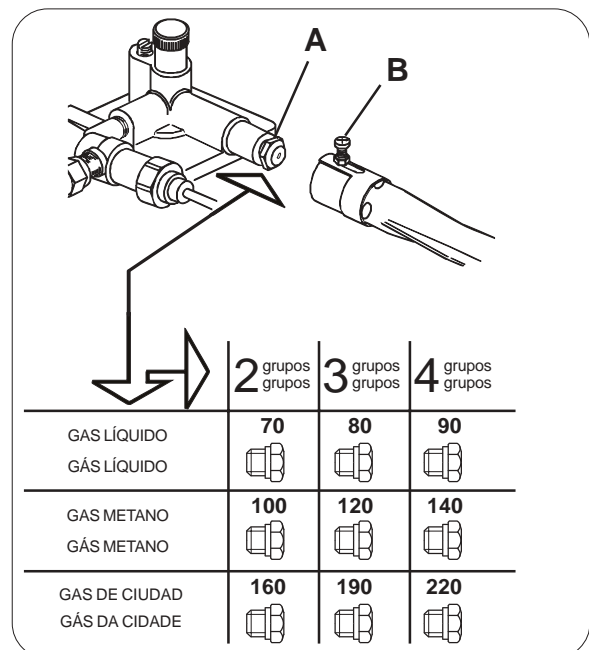

## Installazione - Installation - Installation - Installation - Instalación - Instalação

### **I** ACCENSIONE PIEZOELETTRICA DEL GAS (solo per modelli con + GAS)

Aprire il rubinetto dell'impianto del gas.

Ruotare, premendo, in senso antiorario la manopola rubinetto gas (40) e premere ripetutamente il pulsante accensione piezoelettrica (41) fino a che non si accende il bruciatore sotto la caldaia.

Controllare l'avvenuta accensione dalla finestrella e dopo alcuni secondi rilasciare la manopola (40).

### **GB** PIEZOELECTRIC GAS IGNITION (only for models with + GAS)

Open the gas tap.

Press and turn the gas tap knob (40) counter-clockwise and repeatedly press the piezoelectric switch-on push-button (41) until the burner under the boiler lights up.

Check through the observation window that the burner is lit and, after a few seconds, release the knob (40).

### **F** ALLUMAGE A PIEZO-ÉLECTRIQUE DU GAZ (seulement pour modèles avec + GAS)

Ouvrir le robinet de l'installation du gaz.

Tourner dans le sens contraire, en appuyant, la touche du robinet du gaz (40) et pousser de façon répétée sur le bouton d'allumage piézoélectrique (41) jusqu'à ce que le brûleur qui se trouve sous la chaudière s'allume.

Vérifier l'allumage par la petite fenêtre et, après quelques secondes, relâcher la touche (40).

### **D** PIEZOELEKTRISCH GAS EINSCHALTEN (ausschl. für Modelle + GAS)

Den Gashahn aufdrehen.

Drücken Sie den Gasregler (40), und drehen Sie ihn gegen den Uhrzeigersinn; drücken Sie mehrmals die Taste 'piezoelektrische Zündung' (41), bis daß der unter dem Heizkessel installierte Gasbrenner gezündet wird.

Kontrollieren Sie die Zündung über das Schaufenster, und lassen Sie den Gasregler (40) einige Sekunden nach erfolgter Zündung los.

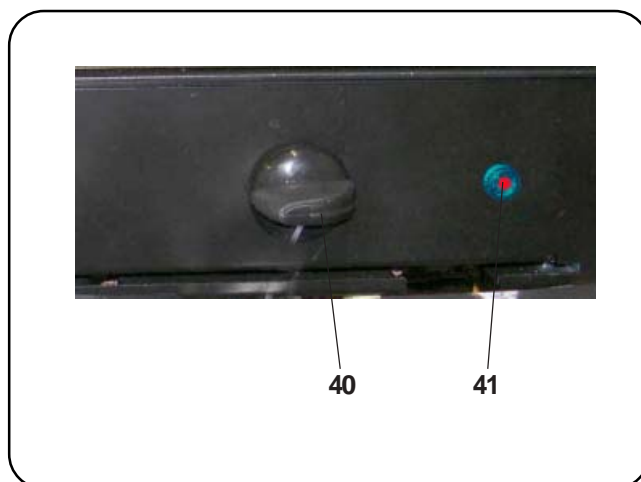

### **E** ENCENDIDO PIEZOELECTRICO DEL GAS (solo para modelos con + GAS)

Abrir el grifo de la instalación de gas.

Girar, apretando, en sentido contrario a las agujas del reloj el mando de la válvula del gas (40) y pulsar repetidamente el botón de encendido piezoeléctrico (41) hasta que no se encienda el quemador que está debajo de la caldera.

Controlar que se hay producido el encendido desde la ventanilla y después de unos segundos dejar de apretar el mando (40).

### **P** ACENDIMENTO PIEZOELECTRICO DO GÁS (apenas para modelos con + GÁS)

Abra a torneira da instalação do gás.

Rodar o manípulo torneira do gás (40) em sentido contrário aos ponteiros do relógio, mantendo o mesmo carregado e carregar várias vezes no botão de acendimento piezoelectrico (41) até o queimador, que se encontra debaixo da caldeira, acender.

Verificar se a janela acendeu e após alguns segundos abandonar o manípulo (40).

## Installazione - Installation - Installation - Installation - Instalación - Instalação

### I IMPIANTO DI RISCALDAMENTO A GAS (solo per modelli con + GAS)

#### Regolazione della combustione

- La fiamma si deve presentare di colore azzurro, non deve staccarsi dal bruciatore e non deve avere bordi giallognoli.
- Posizionare opportunamente la serranda aria "C".
- Altezza della fiamma vedere figura 1.

#### Regolazione della fiamma in esercizio

- Agire sulla vite "D".
- La taratura deve essere inferiore a quella impostata per il pressostato.

#### Regolazione del minimo di esercizio

- Agire sulla vite "E".
- L'altezza della fiamma deve risultare come indicato in figura 2.

### GB CONNECTION TO GAS HEATING (only for models with + GAS)

#### Adjustment of the combustion

- The flame must be blue. It should not be detached from the burner and should not be yellowish around the edges.
- Position the air lock C at the right moment.
- For the height of the flame see figure 1.

#### Adjustment of the flame in operation

- Adjust screw D.
- The calibration must be less than that imposed for the pressurestat.

#### Adjustment of the operating minimum

- Adjust screw E.
- The height of the flame must be as shown in figure 2.

### F INSTALLATION DE CHAUFFAGE A GAZ (seulement pour modèles avec + GAS)

#### Réglage de la combustion

- La flamme doit présenter une couleur bleue claire, ne doit pas se détacher du brûleur ni avoir les bords jaunâtres.
- Bien positionner le bouchoir à air "C".
- Hauteur de la flamme, voir fig. 1

#### Réglage de la flamme en fonctionnement

- Agir sur la vis "D"
- Le calibrage doit être inférieure à celui qui est imposé pour le pressostat.

#### Réglage du minimum de fonctionnement

- Agir sur la vis "E".
- La hauteur de la flamme doit être comme indiqué sur la figure 2.

### D GAS-BEHEIZUNGSANLAGE (ausschl. für modelle + GAS)

#### Verbrennungs-Einstellung

- Die Flamme muss hellblauer Farbe sein, sie muss direkt am Brenner anliegen und darf keine gelblichen Raender aufweisen.
- Die Luftklappe "C" sachgerecht einstellen.
- Zur Flammenhoehe siehe Abbildung 1.

#### Einstellung der Betriebs-Flammenhoehe

- Einstellung bei Schraube "D" vornehmen.
- Die Tarierung muss niedriger als die beim Druckschalter eingestellte sein.

#### Einstellung der Betriebs-Minimalflamme (Sparflamme)

- Einstellung bei Schraube "E" vornehmen.
- Die Flammenhoehe muss der Angabe in Abbildung 2 entsprechen.

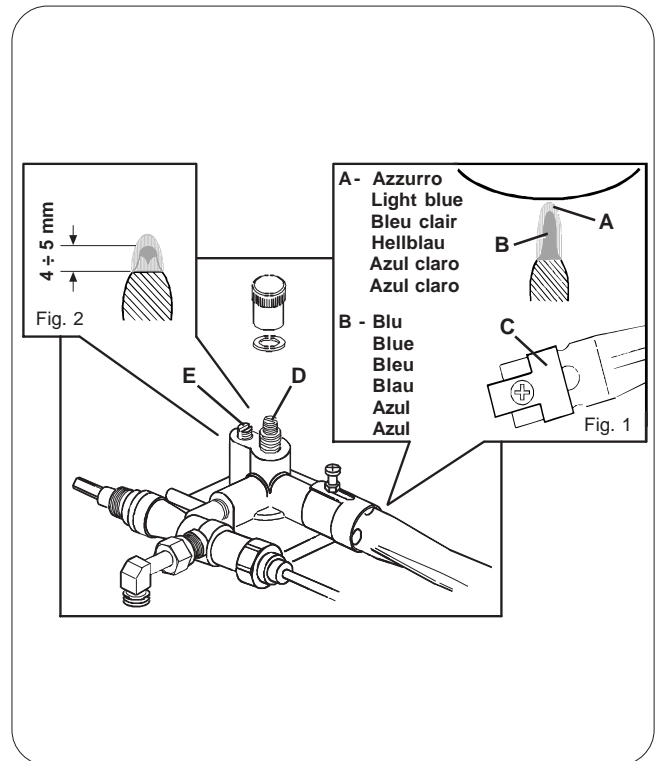

### E INSTALACION DE CALEFACCION DE GAS (solo para modelos con + GAS)

#### Regulación de la combustión

- La llama tiene que ser de color azul, no tiene que alejarse del quemador y no tiene que tener los bordes amarillentos.
- Posicionar oportunamente el cierre metálico de aire "C".
- La llama tiene que ser alta como indicado en la figura 1.

#### Regulación de la llama en ejercicio

- Obrar sobre el tornillo "D"
- La calibración tiene que ser inferior a la establecida por el presóstato.

#### Regulación del mínimo de ejercicio

- Obrar sobre el tornillo "E".
- La llama tiene que ser alta como indicado en la figura 2.

### P INSTALAÇÃO DE AQUECIMENTO A GÁS (apenas para modelos con + GAS)

#### Regulação da combustão

- A chama deve ter uma cor azul, não se deve separar do queimador e não deve ter os bordos amarelados.
- Regular devidamente a abertura do ar "C".
- Altura da chama (ver figura 1).

#### Regulação de chama durante o funcionamento

- Usar o parafuso "D"
- A regulação deve ser inferior àquela programada para o pressostato.

#### Regulação do "Mínimo" de funcionamento

- Usar o parafuso "E"
- A altura da chama deve resultar tal como indicado na fig.2.

## Installazione - Installation - Installation - Installation - Instalación - Instalação

**I****CHECK UP FUNZIONAMENTO****Verificare le condizioni per un buon funzionamento**

- 1) **ALLACCIAMENTO IDRAULICO**  
Assenza di perdite dagli allacciamenti o dai tubi
- 2) **ALLACCIAMENTO GAS**  
Assenza di perdite  
Combustione corretta
- 3) **FUNZIONAMENTO**  
Tenuta valvola antirisucchio  
Pressione in caldaia e d'esercizio rispondenti ai valori normali  
Corretto funzionamento del sensore di pressione  
Corretto funzionamento pressostato del gas (quando esiste)  
Corretto funzionamento dell'autolivello  
Corretto funzionamento delle valvole di espansione  
Verifica dell'erogazione di acqua dal gruppo  
Verifica dosi  
Verifica temperatura di erogazione acqua calda  
Verifica della dose di macinato e della funzionalità del macinacaffè

**F****CHECK-UP FONCTIONNEMENT****Vérifier les conditions pour un bon fonctionnement**

- 1) **RACCORDEMENT HYDRAULIQUE**  
Absence de pertes des raccords ou des tuyaux
- 2) **RACCORDEMENT GAZ**  
Absence de pertes  
Combustion correcte
- 3) **FONCTIONNEMENT**  
Tenue valve anti-remous  
Pression en chaudière et de fonctionnement répondant aux valeurs normales  
Fonctionnement correct du détecteur de pression  
Fonctionnement correct du pressostat du gaz (quand il existe)  
Fonctionnement correct des valves d'expansion  
Vérification du débit d'eau du groupe  
Vérification des doses  
Vérification de la température du débit d'eau chaude  
Vérification des doses de moulu et du bon fonctionnement du moulin à café

**E****CHECK-UP FUNCIONAMIENTO****Verificar las condiciones para un buen funcionamiento:**

- 1) **ENLACE HIDRAULICO**  
No deben verificarse pérdidas en las conexiones o en las tuberías.
- 2) **ENLACE GAS**  
No deben verificarse pérdidas.  
La combustión debe ser correcta.
- 3) **FUNCIONAMIENTO**  
Hermeticidad de la válvula contra el rechupe (anterechupe).  
Presión en caldera y del ejercicio correspondiente a los valores normales.  
Funcionamiento correcto del sensor de presión  
Funcionamiento correcto del presostato del gas (si hay).  
Funcionamiento correcto del auto-nivel.  
Correcto funcionamiento de las válvulas de expansión.  
Comprobación de la erogación de agua del grupo  
Comprobación de las dosis.  
Comprobación de la temperatura de erogación de agua caliente.  
Comprobación de las dosis del molido y del funcionamiento del molinillo.

**GB****CHECK-UP OPERATIONS****For correct operation, check these conditions:**

- 1) **HYDRAULIC CONNECTION**  
Absence of leaks from the connection or from the tubes
- 2) **GAS CONNECTION**  
Absence of leaks  
Correct combustion
- 3) **OPERATION**  
Antisuction valve seal  
Boiler pressure and operating pressure in conformity with normal values  
Correct functioning of the pressure sensor  
Correct functioning of the gas pressurestat (when there is one)  
Correct functioning of the autolevel  
Correct functioning of the expansion valve  
Check of the water output of the group  
Dose check  
Temperature check of the hot water output  
Check of the ground doses and of the functioning of the coffee grinder

**D****RUNDUM-ÜBERPRÜFUNG FUNKTIONSTÜCHTIGKEIT****Überprüfen Sie, ob die Bedingungen für eine einwandfreie Funktionstüchtigkeit gegeben sind:**

- 1) **WASSERANSCHLUSS**  
keine Austritte bei den Anschlüssen und Leitungen vorhanden.
- 2) **GASANSCHLUSS**  
keine Austritte  
sachgerechte Verbrennung.
- 3) **BETRIEB**  
Dichtigkeit des Rucksaugschutzventils  
Kessel- und Betriebsdruckwert entsprechen den Normalwerten  
Einwandfreie Funktion des Druckfühler  
Einwandfreie Funktion des Gas-Druckschalters (sofern vorhanden)  
Einwandfreie Funktion des Wasserniveaureglers  
Einwandfreie Funktion der Überdruckventile  
Überprüfung der Soll-Wasserausgabe aus der Ausgabe Gruppe  
Überprüfung Dosiermengen  
Überprüfung der Kaffeepulver-Dosiermengen und der Funktionstüchtigkeit der Kaffeemühle

**P****CHECK-UP FUNCIONAMENTO****Verificar as condições necessária para se obter um bom funcionamento:**

- 1) **LIGAÇÃO DA ÁGUA**  
Ausência de perdas
- 2) **LIGAÇÃO DO GÁS**  
Ausência de perdas  
combustão perfeita
- 3) **FUNCIÓNAMENTO**  
Vedação da válvula "anti-chupagem"  
Pressão da caldeira e de funcionamento correspondentes aos valores normais  
Perfeito funcionamento do sensor de pressão  
Perfeito funcionamento do pressostato do gás (quando existe)  
Perfeito funcionamento do auto-nível  
Perfeito funcionamento das válvulas de expansão  
Controle da saída de água do grupo  
Verificar as doses  
Controle temperatura do fornecimento de água quente  
Controle da dose de café moido e do funcionamento do moído de café

## Installazione - Installation - Installation - Installation - Instalación - Instalação



**I** **ATTENZIONE:** TERMINATA L'INSTALLAZIONE PRIMA DI INIZIARE IL LAVORO ESEGUIRE UN LAVAGGIO DEI COMPONENTI INTERNI SEGUENDO LE ISTRUZIONI SOTTOINDICATE:

### GRUPPI

- Agganciare i portafiltri ai gruppi (senza caffè).
- Eseguire erogazioni per circa un minuto, per ogni gruppo.

### ACQUA CALDA

- Erogare ripetutamente acqua calda (azionando il relativo comando) sino a prelevare almeno 6 litri per macchina a 2 gruppi, 9 litri per macchina a 3 gruppi, 12 litri per macchina a 4 gruppi.

### VAPORE

- Erogare vapore dalle lance per circa un minuto, usando i relativi comandi.

*N.B.* per eseguire le operazioni sopra riportate vedere le istruzioni riportate nei capitoli **EROGAZIONE.....**



**F** **ATTENTION:** UNE FOIS TERMINÉE L'INSTALLATION ET AVANT DE COMMENCER À UTILISER LA MACHINE, EFFECTUER UN LAVAGE DES COMPOSANTS INTERNES EN SUIVANT LES INDICATIONS REPORTÉES CI-APRÈS.

### GROUPES:

- fixer les porte-filtres aux groupes (sans café);
- faire couler l'eau par chaque groupe pendant 1 minute environ.

### EAU CHAUDE:

- Débitier de façon répétée de l'eau chaude (en enclenchant la commande correspondante) jusqu'à ce que vous ayez prélevé au moins 6 litres d'eau par machine à 2 groupes, 9 litres par machine à 3 groupes, 12 litres par machine à 4 groupes.

### VAPEUR:

- Faire sortir la vapeur des tuyaux pendant environ une minute, en utilisant ses propres touches de commande.

*N.B.:* pour l'émission de l'eau froide ou chaude ou de la vapeur, voir les instructions reportées sur le MANUEL D'UTILISATION ET D'ENTRETIEN.



**E** **ATENCIÓN:** UNA VEZ TERMINADA LA INSTALACION, ANTES DE COMENZAR EL TRABAJO EFECTUAR UN LAVADO DE LOS COMPONENTES INTERNOS SIGUIENDO LAS INSTRUCCIONES MENCIONADAS A CONTINUACION.

### GRUPOS.

- Enganchar los portafiltras a los grupos (sin café)
- Erogar agua de cada grupo durante cerca de 1 minuto.

### AGUA CALIENTE:

- Abrir el agua caliente de forma continua, accionando el mando correspondiente, hasta sacar al menos 6 litros de agua de la máquina a 2 grupos, 9 litros de la máquina a 3 grupos, 12 litros de la máquina a 4 grupos.

### VAPOR:

- Erogar vapor de las lanzas durante aproximadamente un minuto, usando los mandos correspondientes.

*NOTA:* para efectuar la erogación de agua, agua caliente y vapor ver las instrucciones en el MANUAL DE USO Y MANUTENCION.



**GB** **ATTENTION:** AFTER INSTALLING THE MACHINE AND BEFORE STARTING TO OPERATE IT, CLEAN ALL THE INTERNAL COMPONENTS AS DESCRIBED BELOW:

### COFFEE DISPENSERS:

- Connect the (empty) filter-holders to the dispenser units.
- Dispense water from each dispenser for about one minute.

### HOT WATER:

- Dispense hot water repeatedly (using the relative command) until at least 6 liters of water from the 2-group machine, 9 liters of water from the 3-group machine and 12 liters from the 4-group machine.

### STEAM:

- Allow the steam to flow through the nozzles for approximately one minute, using the appropriate commands.

*NOTE:* See the instructions in the USE and MAINTENANCE MANUAL for dispensing water, hot water and steam.



**D** **ACHTUNG:** IST DIE AUFSTELLUNG ERFOLGT MÜSSEN DIE INNEREN BESTANDTEILE GESPÜLT WERDEN, BEVOR DIE MASCHINE IN BETRIEB GESETZT WIRD. MAN MUß DABEI FOLGENDERMAßEN VORGEHEN:

### FUNKTIONSEINHEITEN:

- Die Filterhalter in die Einheiten einrasten (ohne Kaffee).
- Aus jeder Einheit etwa 1 Minute lang Wasser ausströmen lassen.

### WARMES WASSER:

- Wiederholt (über den entsprechenden Steuerbefehl) Heißwasser austreten lassen, bis bei Maschinen mit 2 Abgabeeinheiten wenigstens 6 Liter, bei Maschinen mit 3 Abgabeeinheiten wenigstens 9 Liter und bei Maschinen mit 4 Abgabeeinheiten wenigstens 12 Liter abgegeben wurden.

### DAMPF:

- Führen Sie den Zyklus zur Wasserdampfabgabe etwa eine Minute lang durch, indem Sie wiederholt die entsprechenden Tasten drücken.

*Nebenbemerkung:* In dieser Gebrauchs- und Wartungsanleitung wird erklärt wie man das Wasser, bzw. das warme Wasser oder den Dampf ausströmen läßt.



**P** **ATENÇÃO:** UMA VEZ TERMINADA A INSTALAÇÃO DA MÁQUINA, ANTES DE INICIAR O TRABALHO PROCEDER À LAVAGEM DO INTERIOR SEGUINDO AS INSTRUÇÕES A SEGUIR INDICADAS.

### GRUPOS:

- Prender o manípulo dos filtros aos grupos (sem café).
- Mandar sair água de cada grupo durante cerca de 1 minuto.

### ÁGUA QUENTE:

- Distribuir mais vezes água quente (accionando o respectivo comando) até levantar pelo menos 6 litros de água para a máquina de 2 grupos, 9 litros para a máquina de 3 grupos, 12 litros para a máquina de 4 grupos.

### VAPOR:

- Mandar sair vapor dos esguichos por cerca de um minuto, utilizando os comandos específicos.

*NB:* para proceder à distribuição de água, água quente e vapor consultar as instruções contidas no MANUAL DE UTILIZAÇÃO E MANUTENÇÃO.



## Messa fuori servizio definitiva - Dismantling the machine - Mise hors service definitive

**I** Ai sensi dell'art. 13 del Decreto legislativo 25 luglio 2005, n. 151 "Attuazione delle Direttive 2002/95/CE, 2002/96/CE e 2003/108/CE, relative alla riduzione dell'uso di sostanze pericolose nelle apparecchiature elettriche ed elettroniche, nonché allo smaltimento dei rifiuti"

*Il simbolo del cassonetto barrato riportato sull'apparecchiatura o sulla sua confezione indica che il prodotto alla fine della propria vita utile deve essere raccolto separatamente dagli altri rifiuti.*

*La raccolta differenziata della presente apparecchiatura giunta a fine vita è organizzata e gestita dal produttore. L'utente che vorrà disfarsi della presente apparecchiatura dovrà quindi contattare il produttore e seguire il sistema che questo ha adottato per consentire la raccolta separata dell'apparecchiatura giunta a fine vita.*

**GB** Electrical equipment cannot be disposed of as ordinary urban waste: it must be disposed of according to the special EU directive for the recycling of electric and electronic equipment.

GRUPPO CIBALI electrical equipment is marked with a pictogram of a garbage can inside a barred circle. This symbol means that the equipment was sold on the market after August 13, 2005, and must be disposed of accordingly. Due to the substances and materials it contains, inappropriate or illegal disposal of this equipment, or improper use of the same, can be harmful to humans and the environment.

**F** L'appareillage électrique ne peut pas être jeté comme un déchet urbain. En effet, il faut respecter le ramassage séparé introduit par la discipline visant à l'élimination des ordures dérivant d'appareillages électriques.

Les appareillages électriques du GRUPPO CIBALI sont caractérisés par un symbole portant une benne à ordures sur roues barrée. Le symbole indique que l'appareillage a été mis sur le marché après le 13 août 2005 et qu'il doit faire l'objet de ramassage séparé.

L'écoulement inadéquat ou abusif des appareillages ou encore une utilisation impropre de ces derniers, si l'on considère les substances et matériaux contenus dans ces appareillages, peut provoquer des dommages aux personnes ou à l'environnement.

*L'adeguata raccolta differenziata per l'avvio successivo dell'apparecchiatura dismessa al riciclaggio, al trattamento e allo smaltimento ambientalmente compatibile contribuisce ad evitare possibili effetti negativi sull'ambiente e sulla salute e favorisce il reimpiego e/o riciclo dei materiali di cui è composta l'apparecchiatura.*

*Lo smaltimento abusivo del prodotto da parte del detentore comporta l'applicazione delle sanzioni amministrative previste dalla normativa vigente.*



**MESSA FUORI SERVIZIO DEFINITIVA**  
Per la salvaguardia dell'ambiente  
procedere secondo la normativa locale  
vigente.

Improper disposal of electric equipment that fails to respect the laws in force will be subject to administrative fines and penal sanctions.



**DISMANTLING THE MACHINE**  
To protect the environment, please  
proceed in compliance with the local laws  
in force.

L'écoulement des déchets électriques qui ne respectent pas les normes en vigueur comporte l'application de sanctions administratives et pénales.



**MISE HORS SERVICE DEFINITIVE**  
Pour la sauvegarde de l'environnement,  
procéder selon la normative locale en  
vigueur.



## Endgültige Ausserbetriebstellung - Interrupción definitiva del servicio Colocação fora de serviço definitiva

**D** Elektrische Geräte dürfen nicht in den normalen Haushaltsmüll gegeben sondern müssen entsprechend der Bestimmungen zur Abfalltrennung als Industrieabfall gesondert entsorgt werden.

Die elektrischen Geräte der GRUPPO CIBALI sind mit einem besonderen Kennzeichen (durchkreuzter Müllbehälter) versehen. Dieses Kennzeichen zeigt an, daß das Gerät nach dem 13. August 2005 in den Handel gebracht wurde und im Rahmen der Abfalltrennung als Industrieabfall gesondert entsorgt werden muß.

Eine unangemessene oder nicht den gesetzlichen Vorschriften entsprechende Entsorgung von elektrischen Geräten sowie ein unsachgemäßer Einsatz kann aufgrund der Präsenz von gesundheitsschädlichen Substanzen u/o Materialien zu schweren Gesundheitsschäden und / oder zu einer schwerwiegenden Umweltbelastung führen.

**E** El aparato eléctrico no se debe eliminar como residuo urbano, si no que es necesario respetar la recolección separada de residuos introducida por la Directiva especial para la eliminación de residuos derivados de equipos eléctricos

Los aparatos eléctricos del GRUPPO CIBALI están marcados por un símbolo que representa un contenedor de basura sobre ruedas cruzado por una barra. El símbolo indica que el aparato fue introducido en el mercado después del 13 de agosto de 2005 y que debe ser objeto de recogida selectiva de residuos.

La eliminación inadecuada o abusiva de los aparatos, o bien el uso impropio de los mismos, en razón de las sustancias y materiales que contienen, puede ser nociva para las personas y el medio ambiente.

**P** O equipamento eléctrico não pode ser eliminado como lixo urbano, sendo necessário respeitar a recolha separada introduzida pelo regulamento especial para a eliminação do lixo decorrente de equipamentos eléctricos.

Os equipamentos eléctricos do GRUPPO CIBALI são marcados por um símbolo representando um contentor do lixo sobre rodas barrado. O símbolo indica que o aparelho foi introduzido no mercado depois de 13 de Agosto de 2005 e terá que ser objecto de recolha separada.

A eliminação inadequada ou abusiva dos equipamentos, ou um uso impróprio dos mesmos, em consideração das substâncias e dos materiais contidos pode causar prejuízo às pessoas e ao ambiente.

Jede nicht den einschlägigen Vorschriften entsprechende Entsorgung von elektrischen Materialien beinhaltet die Verhängung von Geldbußen u/o strafrechtlichen Maßnahmen.



**ENDGÜLTIGE AUSSERBETRIEBSETZUNG**  
Hinsichtlich des Umweltschutzes gelten die am Aufstellungsort der Maschine gültigen Vorschriften.

La eliminación de residuos eléctricos que no respete las normas vigentes conlleva la aplicación de sanciones administrativas y penales.



**INTERRUPCIÓN DEFINITIVA DEL SERVICIO**  
Para la salvaguardia del ambiente hay que actuar en conformidad a la normativa local vigente.

A eliminação do lixo eléctrico que não respeite as normas em vigor implica a aplicação de sanções administrativas e penais.



**COLOCAÇÃO FORA DE SERVIÇO DEFINITIVA**  
Para a protecção do ambiente proceder de acordo com o regulamento local em vigor.



## USE

## INDEX

	Page		Page
1. Day-to-day operation	50	4.3 Drinks distribution - steam	55
Forced switch on	51	Autosteam	55
2. Cup-Warmer	52	5. Cleaning and maintenance	56
3. Gas installation switch-on (for + GAS machines)	52	Block function	57
4. Drinks distribution - coffee	53	6. Caution	59
4.1 Drinks distribution - hot water	53	7. Malfunctions	60
4.2 Drinks distribution - milk and cappuccino	54	PROGRAMMING - USER MODE	61

## Certification for materials in contact with food used in FAEMA products

We, **GRUPPO CIMBALI S.P.A.** hereby certify that the cleaning materials (used as specified in the manual) and the materials used in our products in contact with food, are suitable for foodstuff or substances for personal use, in compliance with law CE n° 1935/2004.

### CE Declaration of conformity

According to the EC Directives

We, **GRUPPO CIMBALI S.P.A.** hereby declare that the design and construction of the machines designated below, are conform to the relevant safety and health requirements of the EC Directive.

This declaration shall not apply to machines modified without constructor approval.

Machine type: refer to machine data

Machine number: refer to machine data

Relevant EC Directives: **98/37/CE**  
**2006/95/CE**  
**2004/108/CE**  
**97/23/CE**

**EC Machinery Directive**  
**EC Low Voltage Directive**  
**EC Electromagnetic Compatibility Directive**  
**Pressure Equipment Directive (PED)**

*Description pressure equipment:*

	P <sub>max</sub>	T <sub>max</sub>	Fluid	Capacity (L)			
				2 units	3 units	4 units	
Service boiler	2 bar	133° C	water/steam	10,4 - 11	16,5 - 17,5	22,6 - 24,1	

	P <sub>max</sub>	T <sub>max</sub>	Fluid	Capacity (L)	N° Heat exchanger			
					2 units	3 units	4 units	
Heat exchanger	12 bar	133° C	water	0,65	2	3	4	

Source of applied standards: Via A. Manzoni 17, Binasco (Mi), Italy

Date: 24.01.2008

Signature:

  
CEO

  
QA

# 1. Day-to-day operation

## WITH THE TIMER FUNCTION ON

### With machines using just electrical heating

Turning the machine ON and OFF takes place automatically as programmed.

### With machines using mixed gas/electric heating:

The electrical ON/OFF function does not control gas heating. Therefore, at the end of each day's operating period, you must TURN OFF the gas by turning the gas-tap knob back to the (0) position. The following working day, turn the gas system back ON as described in the "Gas Light-Up" paragraph.

**Note:** when the machine is working in the automatic on/off function do not use the general switch (1) to switch off the machine. If this happens, the machine will **not** be able to switch on again automatically.

## WITH THE TIMER FUNCTION OFF

**Note:** open the lower part of the machine, as shown in figure, to access to the main switch (1):

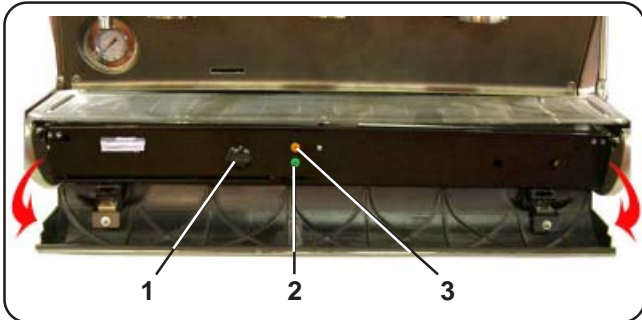

After switching on the machine using the on/off switch (1), the message "PLEASE WAIT" appears on the display. Afterwards, the menu below appears:

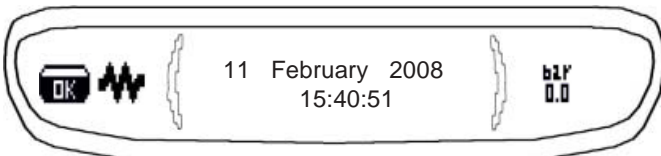

### Description display symbols

 This symbol indicates the boiler water level.

During the loading phase, the dark bottom part of the icon blinks. At the same time the "level Indicator" (3) lights up; (the "optimum level Indicator" (2) switches off).

When the optimum level is reached, the symbol looks like this:

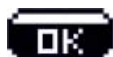

the "optimum level Indicator" (2) lights up; ("level Indicator" (3) switches off)



This symbol indicates that the electric heating in the machine is not functioning.

During the standby phase, the symbol alternates with the icons



to indicate that the (OK) key must be pressed for a few seconds to activate the boiler resistance.

When the resistance is activated and functioning, the icon looks like this



When the boiler pressure reaches the set value, the icon looks like this



When the machine is in operation, the two icons



alternate on the display, indicating the presence of the electric heating.

**Note:** When the on/off function is programmed, the electric heating takes place automatically without having to press the key (OK).

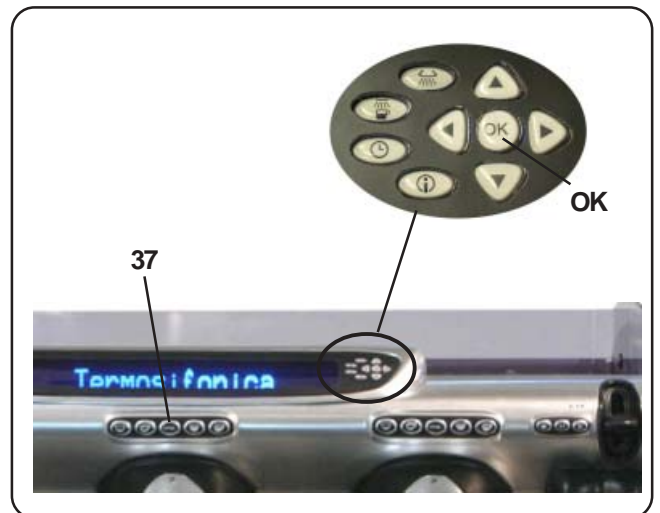

This symbol indicates the boiler pressure value.



This symbol indicates that the machine is pre-heating or the boiler pressure has dropped below 0.5 bar.

In this condition the symbol alternates with the icon of the boiler pressure value .

If one of the "STOP/continuous coffee" (37) keys is pressed, coffee will be served at the temperature reached at that moment.

All of the other keys are disabled because the working pressure has not been reached.

While waiting for the machine to be ready for use, insert the filter holders in the units.

The machine has reached the set work pressure and temperature when the icon



disappears from the display.

Press a coffee selection key for each keypad to adjust the temperature between the group and filter holder.



This symbol indicates that a services card has been inserted in the slot (39) and, therefore, the technical programming menu can be accessed.

### Forced switch on

When the programmed switch off function is active, the following message is displayed:

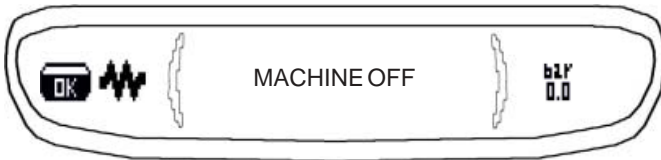

Press the "STOP/Coffee continue" (37) key to force the

machine on again.

N.B. Forcing the machine on does not change the programmed on/off times.

**N.B.** At this point the machine will remain on until the next switch off time is reached.

To immediately return the machine to "off" as originally programmed, switch it off and on again using the general on-off switch (1).



## 2. Cup-Warmer

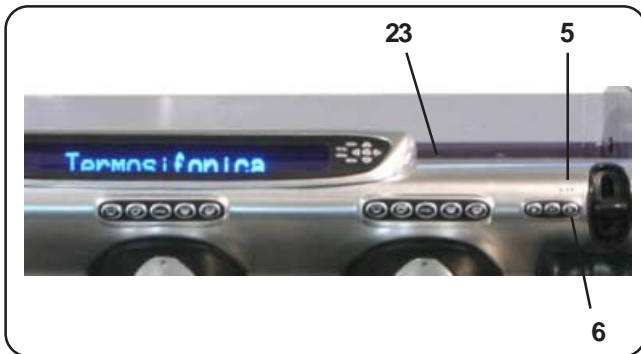

**CAUTION: do not put any cloth on the cup-warmer.**

The machines have a cup warmer tray (23) for stocking and pre-heating the cups.

Only place cups and glasses used with the coffee machine on the cup tray. **No other objects must be placed on the tray.** Thoroughly drain the cups before placing them on the tray.

To activate the resistance of the cup warmer tray (23) press button (6); to change the cup-warmer power, press the (6) key a number of times.

- All LEDS (5) on = full power
- All LEDS (5) off = OFF

To desactivated the heating of tray (23) press more times the key (6) until all the leds are off.

N.B. The heating of the cup warmer tray (23) is deactivated during the automatic switch off phase.

The condition in effect at the time when the machine was switched off will be restored the next time the machine automatically switches on.

## 3. Gas installation switch-on (for + GAS machines only)



**" Don't switch on the gas installation when the boiler is under pressure ".**

Before using the machine check that:

- the main electricity supply ON/OFF switch is ON;
- the main water supply tap is open .
- the gas supply tap is open.

Turn the main switch ON/OFF (1) to position 1.

The machine completes the operations described under "**Daily Switch-On**".

Press and turn the gas tap knob (40) counter-clockwise and repeatedly press the piezoelectric switch-on push-button (41) until the burner under the boiler lights up.

Check through the observation window that the burner is lit and, after a few seconds, release the knob (40).

"**Heating**" now begins.

At the end of the day, switch off the machine by turning the ON/OFF switch (1) to the "0" position and close the gas tap (40) by turning it to the "0" position.

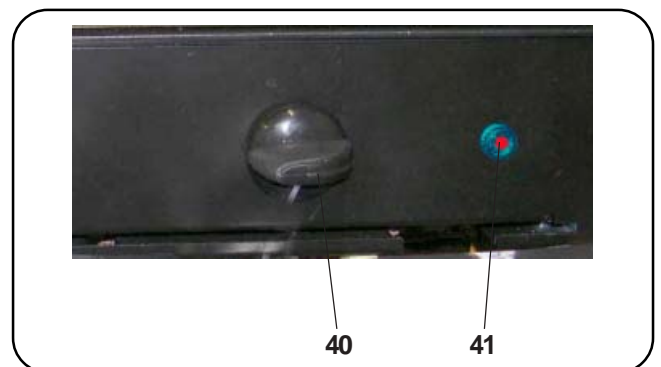

## 4. Drinks distribution - coffee

Remove the filter carrier (**21** or **25**), clean it of the used coffee grounds and refill it with 1 or 2 doses of ground coffee, according to the filter carrier used.

Press the coffee evenly in the filter, using the dose-grinder press.

Remove any coffee grounds from the edges of the filter.

Insert the filter carrier (**21** or **25**) to the group, locking it firmly in place. Position the cup (or cups) under the spout (or spouts) of the filter carrier (**21** or **25**).

Press the coffee distribution key (**32**, **33**, **35** or **36**) corresponding to the desired dose. The corresponding led lights up, the coffee will be issued and will stop automatically upon completion.

Press the continuous/STOP distribution button (**37**) for a continuous distribution.

The distribution, both dosed and continuous, may be interrupted at any time by pressing the continuous/STOP key (**37**).

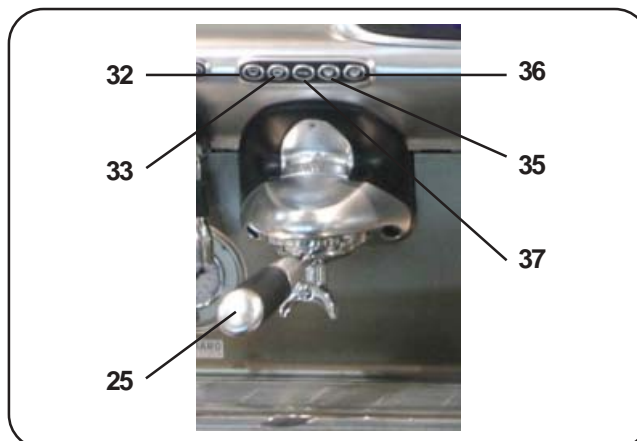

### 4.1 Drinks distribution - hot water

After having positioned the appropriate container under the hot water nozzle (**32**), distribution is made in two ways.

#### DOSED FUNCTION

Press one of the hot water distribution keys (**13a** or **13c**). The corresponding led will light up, hot water will be issued and will stop automatically upon completion.

The distribution may be interrupted at any time by pressing the previously active key again (shown by the lighted led), or the Stop button, continuous hot water (**13b**).

#### CONTINUOUS FUNCTION

Press the hot water distribution key (**13b**).

Hot water will be issued continuously until the hot water key (**13b**) is pressed again to stop this function.

In continuous function the programmed dosed in the key is not changed.

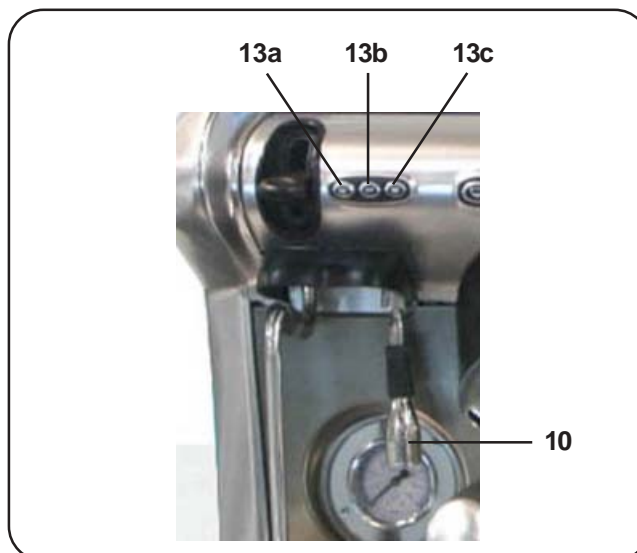

## 4.2 Drinks distribution - milk and cappuccino

### GENERAL INDICATIONS

Milk is a delicate biological product and can easily deteriorate. Heat modifies its structure. Milk must be kept at a storage temperature **no higher than 5°C (41°F)** from the moment the container is opened and throughout its entire period of use. Our storage appliances are suitable for this purpose.

NOTE: at the end of the work day (or not more than 24 hours from the time the container is opened), any remaining milk must be discarded.

### MEMORIZATION OF TYPES OF BEVERAGES

By using the following combinations, the “automatic cappuccino-maker” and the programming capability provided for each button of the right dispenser unit permit making different types of beverages according to the local customs and preferences:

- frothed milk
- frothed milk + coffee
- frothed milk + decaffeinated coffee
- dispensing first the coffee and then the milk
- dispensing coffee and milk simultaneously.

The desired programming is done by the installing service technician.

### MILK SUPPLY

Plunge the small pipe (18d) into the milk container.

After having positioned the container under the cappuccino-maker (18), the milk can be supplied in this way:

### MEASURED QUANTITY OF MILK

Press the milk supply button. The led above the button lights up, the milk flows out and then stops automatically. The flow may be stopped at any time by pressing the START-STOP push button (37).

### PREPARATION OF CAPPUCCINO (Milk frother machines)

- **Just use the filter-holder that has a single spout.**
- Remove the filter-holder from the dispenser unit and remove all the used coffee grounds; then fill with fresh ground coffee and press firmly.
- Insert the filter-holder (10) into the dispenser unit and secure firmly.



- Plunge the small pipe (18d) into the milk container.
- Place a cappuccino cup or other appropriate container under the spout; with the special spout of the milk frother (18), the cappuccino cup or other container must not be moved between the dispensing of the coffee and milk.
- Press the corresponding selection button. The LED above the button will light up and dispensing will begin. Dispensing turns off automatically. Dosed serving dispensing can be interrupted at any time by pressing the START-STOP push button (37).

For more information on the function please consult the specific leaflet.



**CAUTION:** After a long inactivity, the hygienic norms relevant to milk conservation shall be followed.

### 4.3 Drinks distribution - steam

Completely immerse the right (9) or left (20) steam nozzle into the container with the liquid to be heated and push the steam control lever (11 or 17) upwards.

Wait until the liquid has reached the desired temperature, then lower the steam command lever to stop the issue of steam.

**Note:** At the conclusion of each steam dispensing phase, clean the inside of the steam nozzle as follows:  
**Turn the nozzle towards the cup tray and carefully activate steam dispensing at least once.**

**Dispensing with the Autosteam (Turbosteam) selector (12)**  
 (when provided)

Machines equipped with the AUTOSTEAM (STOP STEAM) dispensing system have the "stop steam dispensing when set temperature is reached" function, and can rapidly heat and froth milk.

Select the type of milk you desire:

- using the buttons **12a** (frothed) or **12b** (hot);

After selecting the type of milk you desire (heated or frothed), insert the steam nozzle (**9a**) into a suitable container, making sure the bulb is completely immersed in the milk.

After pressing the key (**12a** or **12b**), the temperature detected by the probe appears on the display.

When the set temperature is reached, steam dispensing can be stopped:

- automatically;  
 - manually, pressing buttons **12a** or **12b** again.

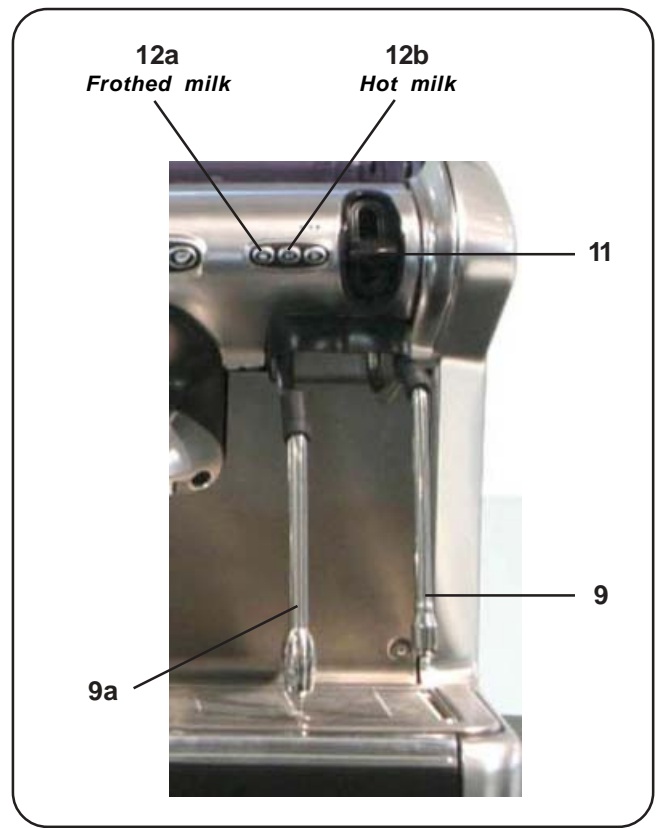

## 5. Cleaning and maintenance



For correct application of the HACCP system, please follow the instructions in this paragraph.

### MILK CIRCUIT AND COFFEE CIRCUIT CLEANING CYCLES

The purpose of the flushing cycle is to remove all traces of grease and scaling deposited when the milk is conveyed and emulsified and when the coffee is dispensed. Failure to flush out the circuit will allow these deposits to solidify. This will impair the qualitative performance of the cappuccino maker and of the coffee circuit.

**NOTE: the following operations must be carried out when the machine is on and pressurized.**

**ATTENTION, RISK OF SCALDING:** During the wash cycles, hot water, steam and milk residues will exit the cappuccino nozzle and filter holders (21/25). Keep the hands and all other parts of the body well away until the cleaning cycle has terminated.

### MILK CIRCUIT AND COFFEE CIRCUIT WASHING CYCLES

#### Daily wash cycle at set hour

**Function** - The message "EXECUTE WASHING MILK CIRCUIT" in alternation "EXECUTE WASHING GROUP 1" appears on the display at the set hour (consult the "Customer programming - Service time menu" paragraph).

**Activation - milk circuit:** through key (28) on the selection keypad. The message "MILK WASHING" appears on the display.

**Coffee circuit:** according to the methods described in "COFFEE CIRCUIT WASHING CYCLE"; the message "GROUP WASH" accompanied by the group number will appear on the display.

**Selection block - milk circuit:** 60' function from the hour set if wash cycle has not taken place, with the "Block milk circuit" function set (YES).

**Coffee circuit:** 60' from the hour set if wash cycle has not taken place, with the "Block coffee circuit" function set (YES).

**Wash type** - \* *milk circuit:* with water and steam, and with an external detergent in the place of the milk.

\*\* *Coffee circuit:* with the detergent solution inserted in the filter holder.

For more details, please consult the "Configuration menu - wash options" paragraph.

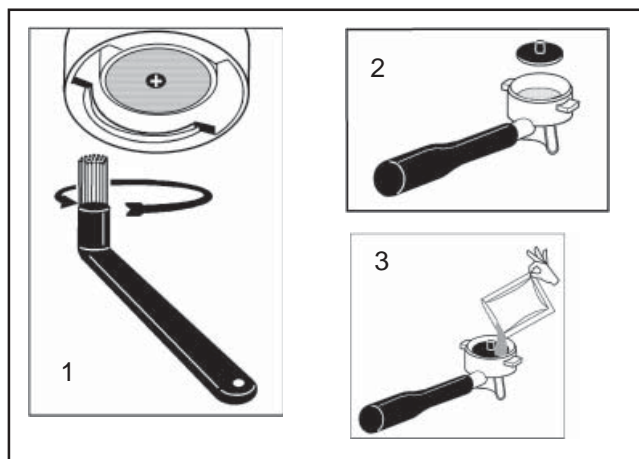
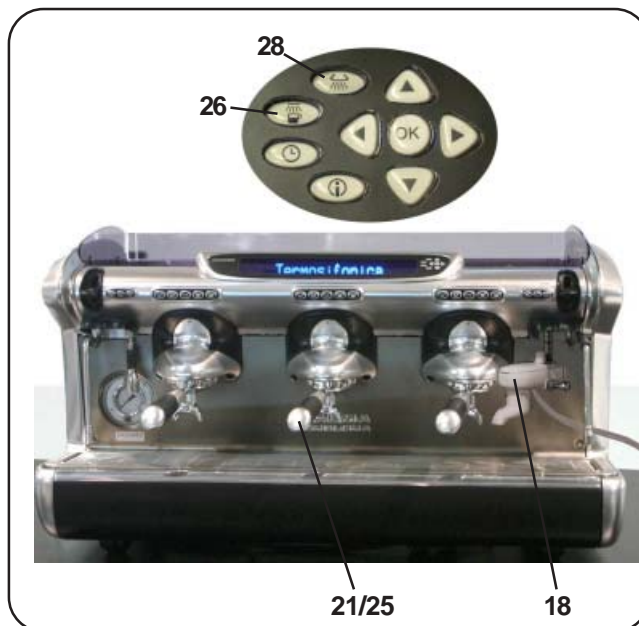

#### \*MILK CIRCUIT WASHING CYCLE

First left-hand dispenser unit with cappuccino-selection panel

(only for machines with cappuccino maker):

(Be careful, steam will come out of the cappuccino-maker's dispensing spout).

- 1) Fill a container with ½ litre of cold water and one dose of liquid detergent (see product instructions).
- 2) Remove the suction tube from the milk container and immerse it in the solution.
- 3) Use command on the machine to suck detergent in. The detergent sucked in and heated will clean the "cappuccinatore".
- 4) Detergent should be sucked till steam comes out.

For "CAPPUCCINO MAKER" cleaning instructions and methods, please consult the specific leaflet.



## 5. Cleaning and maintenance

### \*\*COFFEE CIRCUIT WASHING CYCLE

To be performed at the end of the working day or when requested by the machine.

The machine will issue a message on the display "EXECUTE WASHING GROUP 1".

This will be repeated until the operation is performed.

To perform the wash cycle, follow this procedure:

- 1) Using a brush, clean the cover gasket, as shown in figure 1.
- 2) Press and hold down the coffee circuit wash key (26); for a few seconds. The message "INSERT GROUP 1 FILTER HOLDER" will appear on the display.
- 3) Insert the rubber disk into the filter-holder with its filter (fig. 2); pour in a packet or dosing cupful of detergent powder (fig. 3).
- 4) Press the coffee circuit wash key (26). The Group 1 wash cycle will start and the "GR1 WASH" message will appear on the display.
- 5) At the end of the group 1 wash cycle, the message "REMOVE GROUP 1 FILTER HOLDER" will appear.
- 6) Press the coffee circuit wash key (26). The message "RINSE GR1" will appear.
- 7) At the end of the group 1 rinse cycle, the message "GROUP 2 WASH" will appear.
- 8) Repeat the operations described above for all machine groups.

**Note: If no wash cycle messages appear and the machine is used frequently, a wash cycle can be performed at any time, using the methods described earlier:**

- milk circuit washing cycle: pressing the (28) key;
- coffee circuit washing cycle: pressing the (26) key;

**Note: once the wash cycle is underway, it CANNOT be stopped, even if the machine is switched off.**

**If there is a power failure, when power is returned the message "EXECUTE WASHING GROUP" will be displayed. Complete the cleaning operations as described previously.**

**The wash cycles performed without request by the machine can be interrupted by switching off and switching back on the machine.**

The wash cycle lasts about 7" for each group.

Programmed wash cycles that are not effected will be memorized by the machine.

### Block function

When the machine is blocked, a warning message appears on the display: if the key corresponding to the requested wash cycle is pressed (key 26 or 28) and the instructions on the display are followed, the wash cycle is performed and the machine is no longer blocked.

For example, if there is a "coffee block", the following message appears on the display:

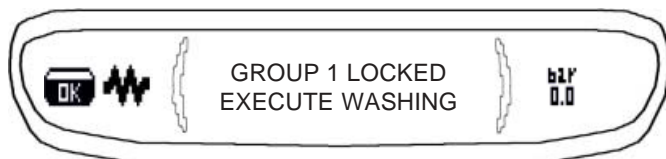

The number of the "blocked group" blinks on the display and depends upon the number of machine groups.

If the coffee wash circuit key is pressed (26), the previous message will be integrated as shown:

**GROUP 1 LOCKED  
EXECUTE WASHING**

**INSERT FILTER HOLDER  
GROUP 1**

When the "INSERT FILTER HOLDER - GROUP 1" message appears, the block message for Group 1 disappears. The block messages for groups still to be washed appear in alternation.

At this point, please follow the steps described in the "\*\*\*COFFEE WASH CIRCUIT" paragraph to perform the washing cycle.

## 5. Cleaning and maintenance

### Filter-holders

- 1) Put a liter of cold water in a suitable container and add detergent.
- 2) Soak the filter-holders in this solution for about 2 hours.
- 3) Remove the filters from the filter-holders and wash the parts in the same detergent solution, using a small sponge.
- 4) Flush thoroughly with cold water.
- 5) Reinstall the filters in the filter-holders, making sure that filter-retainer spring seats properly.

### Steam and hot water dispensing pipes

Using a clean sponge, wash with hot water removing any organic residue present. Rinse carefully.

To clean the inside of the steam nozzle, follow these steps: Turn the nozzle towards the cup tray and carefully activate steam dispensing at least once.

### Grille and Drip Basin

Remove the grille from the basin, extract the grille section (as indicated in the figures) and complete the cleaning operation under running water.

### Discharge Basin

At the end of the working day, pour about a liter of hot water into it to remove any discharge residues.

### Bodywork

Use a soft cloth and cleaning products **WITHOUT** ammonia or abrasives, removing any organic residue present in the work area.

N.B. Do not spray liquids into the panel slots.

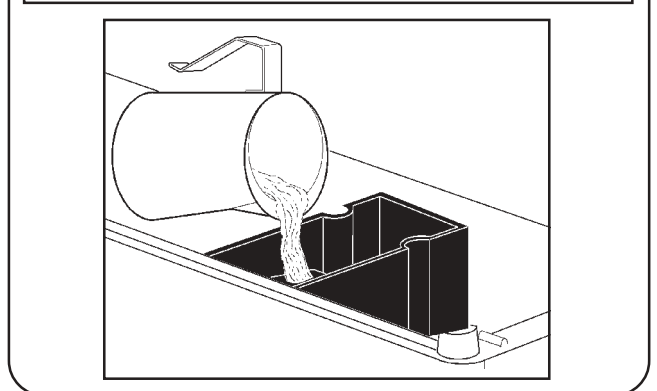
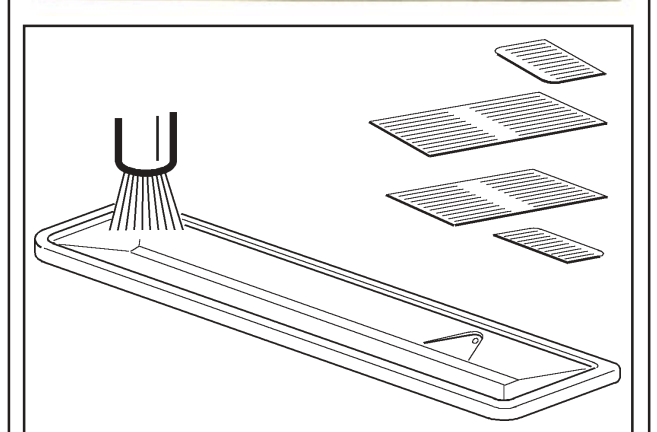

### ATTENTION

When the machine has not been used for more than 8 hours, and in any case once a day, the internal components must be washed before use, in accordance to the following instructions:

#### Supply Groups

Insert the filter carriers into the groups (without coffee) and dispense from each group for one minute.

#### Hot water

Dispense hot water repeatedly (using the relative command) until at least 6 liters of water have been dispensed from the 2-group machine, 9 liters of water from the 3-group machine and 12 liters from the 4-group machine.

#### Steam

Allow the steam to flow for approximately one minute, using the appropriate commands.

## 6. Caution



### Danger of burns

The areas marked with this sign become hot. **Great care should be taken when in the vicinity of these areas.**



**WARNING:** Hot surface  
**ACHTUNG:** Heisse Oberfläche  
**ATTENTION:** Surface chaude  
**ATTENZIONE:** Superficie calda

### GENERAL

**Use of gas operated appliances in premises smaller than 12 m<sup>2</sup> is not permitted.**

**If a gas heated installation is used, change the flexible tube at the due expiry date.**

**The manufacturer disclaims all liability for damages to items or persons due to improper use or due to the coffee machine being used for reasons other than its intended use.**

Never work the coffee machine with wet hands or naked feet.

### Cup-warming plate

Place only coffee cups, cups and glasses to be used in conjunction with the coffee machine on the cup-warming plate.

Ensure that the coffee cups are completely drained before placing them on the cup-warming plate.

No other objects shall be placed on the cup-warming plate.

### MACHINE CLOSE-DOWN

**When the machine remains unattended for a long period of time (at night, during the weekly closing day or during holidays) the following operations shall be performed:**

- **Remove the plug or switch off the main switch.**
- **Close the water tap.**
- **Close the gas tap.**

**Non-compliance with these safety measures exonerates the manufacturer from all liability for malfunctions or damage to persons or items.**

### Danger of Burns

Do not place the hands or other parts of the body close to the coffee distribution points, or near to the steam and hot water nozzles.

Ensure that the machine is not handled by children or persons who have not been instructed in its correct use.

### MAINTENANCE AND REPAIR

If the machine does not function correctly, switch it off, turn off the main switch and call the service agent.

**Only qualified and authorised servicing personnel should be called.**

**Use only original spare parts.**

**Maintenance activities performed by unqualified personnel may jeopardise the safety of the machine.**

If the electric cable is damaged, switch off the machine and apply to the servicing department for a replacement.

**The following measures are indispensable for ensuring operational and functional safety:**

- **Comply with all the manufacturer's instructions.**
- **Ensure that specialized technicians periodically verify that the protection devices are intact and that all the safety devices function correctly (the first inspection should be made within 3 years and subsequently once yearly).**

### Regeneration of the Water Softener

The machine must be installed with an ionic resin water softener.

The water softener may be of different types, with different resin capacities and different periods of validity.

The resins are regenerated by adding coarse kitchen salt or salt pastilles to the water softener.

If the regeneration of the resins is not made at the due dates, calcareous deposits will form which progressively decrease the machine's efficiency until its functions are completely blocked.

The regeneration due dates and method thereof may be found in the instructions provided with the equipment.

If regeneration is performed at the due dates, the machine is maintained in ideal working conditions.

## 7. Malfunctions

### Direct intervention by the customer

In order to avoid unnecessary costs, ensure that the problem occurring in the machine is not included in the following table before calling the servicing department.

DEFECT	CAUSE	REMEDY
The coffee machine does not work and the display (14) is blank.	No electricity.	Check that the electricity is on. Check the position of the main switch (1).
The coffee machine does not heat up.	The boiler resistance enabling key (OK) was not pressed	Press the key (OK)
Leak from edge of filter-holder (21, 25).	The undercup gasket is dirty with coffee residue.	Clean with the supplied brush.
Coffee flow time too short.	Coffee grinds too coarse. Coffee too old.	Grind the coffee more finely. Change the coffee
Water leaks from under the machine.	Drainage tank clogged. Discharge pan hole blocked.	Clean the tank. Clean.
Machine heated up, but it does not dispense coffee.	Water supply or water softener tap closed. No water in system.	Open. Wait until water is available or call a plumber.
The automatic level control devices remain in operation.	Same causes as above.	Same solution as above.
The coffee is warm and weak (after normal time of brew and flow).	Air bubble in thermosyphonic circulation system.	Press the coffee distribution button 2/3 times to try and eliminate the air bubble.
The reading on the pressure gauge (8) of the pump pressure is greater than 9 bars.	The pump's by-pass valve is blocked.	Call the authorized servicing department.

# PROGRAMMING - USER MODE

## INDEX

	Page
1. Data flow chart - Customer programming	62
2. Clock adjustment	63
3. How to access the programming mode	63
3.1 Key menu - Coffee selection	64
3.2 Key menu - Cappuccino - Milk selection	64
3.3 Key menu - Hot water selection	65
Programming measures using the "SELF-LEARNING"	65
4. CUSTOMER PARAMETERS menu	66
Language selection	67
5. DATA menu - Counter display and zeroing	67



1. Data flow chart - Customer programming

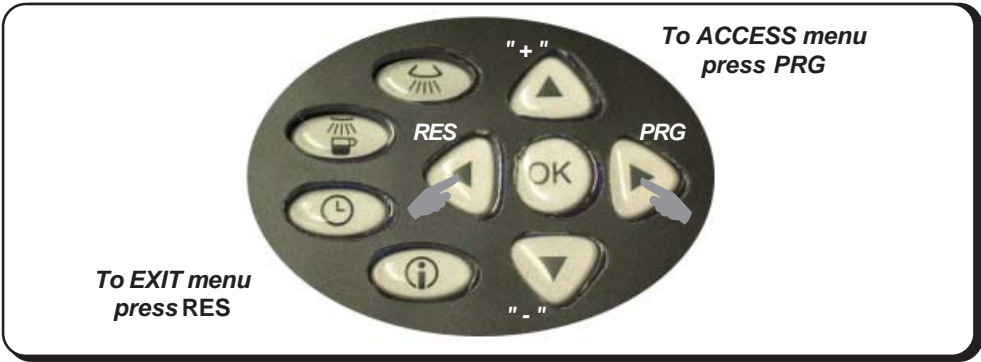

Only if "Prog. cliente" is YES and "Program. block" is NO

**KEYMENU**

Press SELECTION KEY

**Type**

Cappuccino flow

Milk dose

Coffee start/Milk start

Water dose

**DATAMENU**

Press

**COUNTERS**

N° coffee..

N° milk

N° water

N° steam

N° steam TS

N° steam + air TS

N° tot coffee

**CUSTOMER**

Press

**SERVICETIME**

DATEANDTIME

ON time

OFF time

Day off

Night ON

Night OFF

WASH 1

WASH 2

WASH 3

ITALIANO

ENGLISH

FRANCAIS

DEUTSCH

NEDERLANDS

ESPAÑOL

PORTUGUÊS

漢語

**EXITING THE PROGRAMMING MENUS**

*Before exiting the menus:*

- Press the OK key to confirm any changes made to settings;
- Press the RES key to leave settings unchanged

The icons below will appear alternating on the lower part of the display:

## 2. Clock adjustment

Use the "+" (30) and "-" (31) keys to adjust the clock.  
The time increases (or decreases) one minute each time the key is pressed.

If one of the keys (30 or 31) is pressed and held down for more than 10 seconds, the minutes setting stops and the hours setting increases (or decreases).

During the time setting phase, the seconds remain at "00".

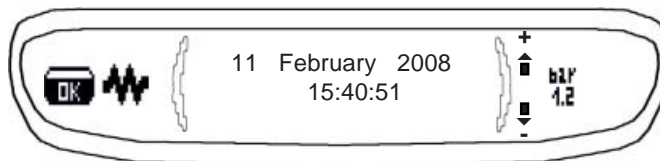

## 3. How to access the programming mode

**N.B. ONLY** if the item "Customer Progr." is set on "YES" and the item "Program. block" is set on "NO".

To access programming press the PRG (29) key; the following message will appear on the display:



Press one of the dispensing keys on the selection panel; the relative led will remain on.

Use the "+" (30) and "-" (31) keys to position the cursor on the desired line, then press the PRG (29) key.

Always use the "+" (30) and "-" (31) keys to change the setting; at this point there are two possibilities:

- 1) confirm the changes made by pressing the **OK** key
- 2) exit the menu and leave the settings unchanged by pressing the **RES** key

**Note:** When modifying data, the cursor changes to "→", or a slide bar with maximum and minimum settings will appear:



If the "Customer Progr." is set to "NO", the following message will appear on the display:

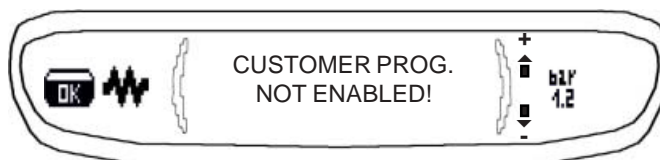

### 3.1 Key menu - Coffee selection

Press one of the coffee dispensing keys on the selection panel (the relative led will remain on, not flashing). The following message will appear on the display:

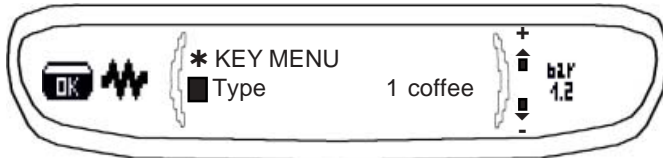

Each dispensing unit is controlled by a panel that permits programming the amount of desired dispensing for each button.

The following coffee selection parameters can be modified:

- **water dose** (volumetric dosage pulses)

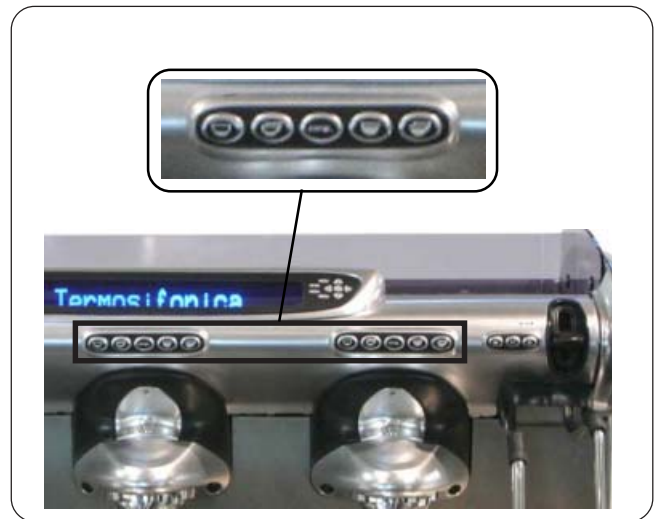

### 3.2 Key menu - Cappuccino - Milk selection

Press one of the cappuccino – milk dispensing keys. The related LED remains on and does not blink. The display appears as follows:

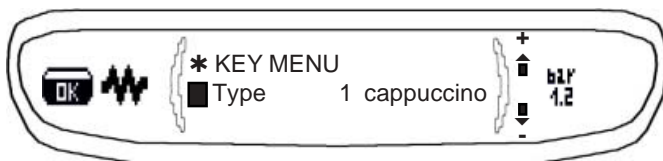

Cappuccino-milk selection parameters that can be changed are:

- **Milk dose** (milk dispensing time);
- **Milk start/coffee start** \*\* (milk dispensing delayed after coffee dispensing, and vice versa)
- **Water dose** (volumetric dosage pulses)

#### (\*\*) Start milk/Start coffee function

The cappuccino beverage can be made as follows:

- First dispensing coffee and then milk.
- First dispensing milk and then coffee.

You can use the "+" (30) and "-" (31) keys to change the "Start milk" setting (milk dispensing start delayed after coffee dispensing and vice versa) from "00" to "99" with "1" second increments.

If over "99" is set, the "Start milk" setting will become the "Start coffee" setting (coffee dispensing start delayed after the milk dispensing), then the setting returns to "Start milk" in a cycle.

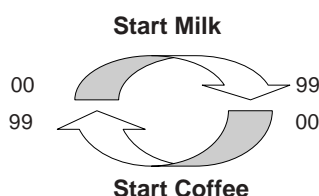

The default settings for cappuccino selections are: Start milk 00.

By setting:

"Start milk 00" - milk dispensing takes place when the selection key is pressed. After a few seconds, coffee is dispensed;

"Start milk 99" or at a high setting that exceeds the coffee dispensing time - milk dispensing starts after coffee is dispensed.

"Start milk 05" - coffee dispensing starts, and 5 seconds after the selection key is pressed, milk is dispensed.

Note: If the time setting exceeds the coffee dispensing time, milk dispensing begins immediately after coffee is dispensed.

"Start coffee 00" - Coffee dispensing starts after milk is dispensed.

"Start coffee 99" or any setting other than 0 - coffee dispensing will start 99 seconds (or after the set time) after milk is dispensed.

### 3.3 Key menu - Hot water selection

Press the hot water dispensing key. The following message will appear on the display:

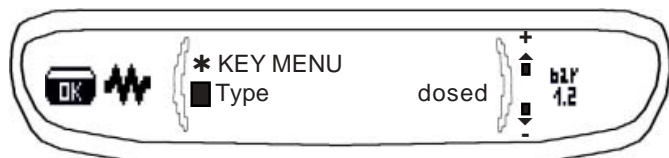

The following hot water selection parameters can be modified:

- **water dispensing time** (dispensing time in seconds.).

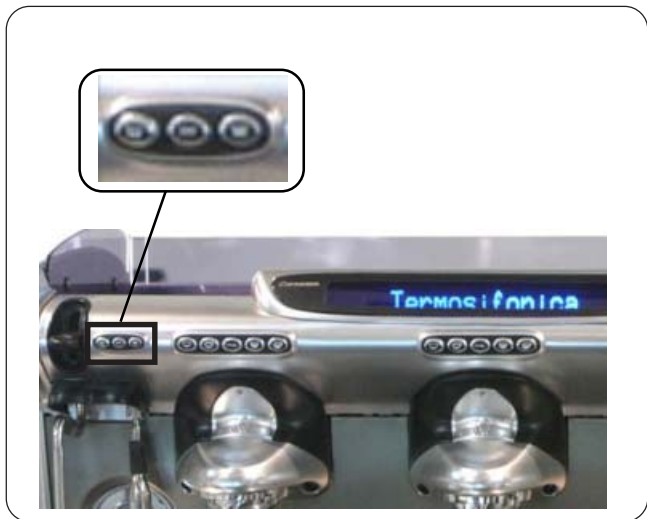

#### Programming measures using the "SELF-LEARNING" function

The water doses for coffee and the hot water doses can also be set using the "SELF-SETTING" function:



press and hold the STOP button for at least 8 seconds or until you hear a buzzer sound that will keep sounding throughout the programming. The menu below will appear on the display, showing the keys with the relative quantities for water for the coffee.

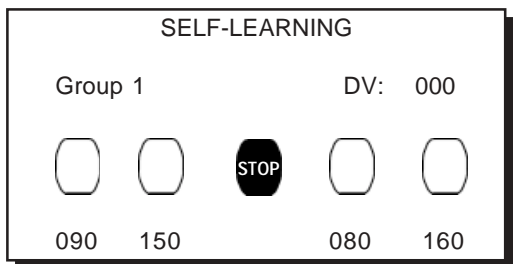

#### Coffee measures

- 1 - Fill the filter-holder with the required dosage of ground coffee and insert it in the dispenser unit.
- 2 - Put the cup or container under the filter-holder spouts and press the button to be programmed. Keep it pressed until the desired level is reached in the cup or container.



During this phase, the setting for the volumetric dosage pulses (top right of display) is increased. When the key is released, the setting reached is memorized and appears under the programmed key.

- 3 - Starting from step 1, continue programming, as desired, on all the coffee buttons.

#### Hot water measures

- 1 - Press the button to be programmed and keep it pressed until the desired level is reached in the cup.



During this phase the time in seconds (top right of display) is increased; when the key is released, the setting reached is memorized and appears below the programmed key.

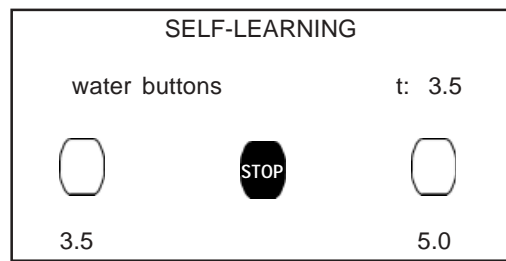

- 2 - Starting from step 1, continue programming, as desired, on all the water buttons.

When finished, press the STOP button. The buzzer will turn off, thus confirming that the programming has been completed.

## 4. CUSTOMER PARAMETERS menu

To access "Customer parameters" press "☰" key (34); the message shown below will appear on the display:



Pressing the "PRG" key (29), the following message will appear on the display:

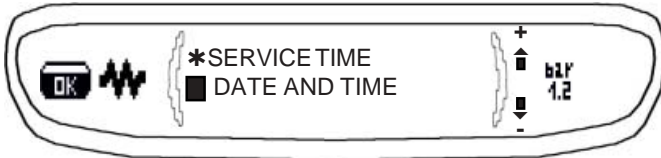

The following service time parameters can be modified:

- **ON time** (time the machine switches on);
- **OFF time** (time the machine switches off);
- **day off** (day on which the enterprise is closed);
- **Night ON** (start time for evening beverage price: only when payment system is connected);
- **Night OFF** (end time for evening beverage price: only when payment system is connected);
- **Wash 1** (request - every 24 hrs - at the programmed hour; cannot be disabled);
- **Wash 2** (hour of scheduled washes 2)
- **Wash 3** (hour of scheduled washes 3)

Pressing again the "PRG" key (29), the following message will appear on the display:

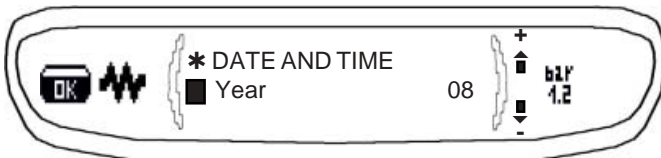

Use the "+" (30) and "-" (31) keys to move the cursor █ to the entry to be modified, then press the "PRG" (29) key. The cursor will turn into an arrow → and it becomes possible to change the number for the selected entry by using the "+" (30) and "-" (31) keys.

Once the operation is completed, press the "RES" (24) key to confirm the data.

Note: the cursor changes back to █.

Repeat the operation described above to modify other parameters.

### General indications

If there is no day off (i.e. the enterprise never closes), enter "none" for the "day off" item.

Enter the same time for the "ON time" and "OFF time" parameters (for example:

ON time	22:00
OFF time	22:00

if the automatic switch on/switch off function is not required and you wish to manually switch the machine on and off.

### "WASH 1", "WASH 2" AND "WASH 3"

These are scheduled washes that are independent of the wash cycles related to the switching on and switching off phases.



After having positioned the cursor on the line to be changed and after having pressed the "PRG" (29) key, change the value using the "+" (30) and "-" (31) keys. Then press the "RES" (24) key to confirm.

Repeat the above operations to change the other wash scheduling times.

### "Wash 1", "Wash 2", "Wash 3"

When these functions are requested, a long wash cycle is performed (milk circuit and coffee circuit) as described in the "Cleaning and maintenance" paragraph.

If the set hour for these wash cycles occurs when the machine is switched off, the request will be canceled.

NOTE: Set OFF against the time so as to not activate these wash cycles.

OFF is displayed press the "-" (31) key the indicated time is "00:00"

For more details, please consult the "Configuration menu - wash options" paragraph.



### Language selection

To display the messages in a different language from that set, after entering into Programming mode, position the cursor on the desired language by pressing the "+" (30) and "-" (31) keys and then pressing the "PRG" (29) key. The machine will restart with the messages provided in the selected language.

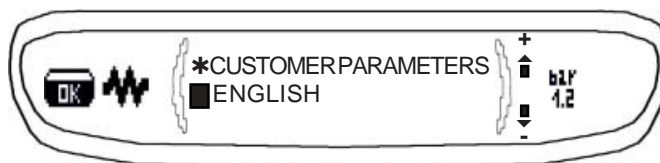

The display (14) provides a choice of the following languages.: Italian, English, French, German, Dutch, Spanish, Portuguese and Japanese.

## 5. DATA menu - Counter display and zeroing

Counters are displayed by pressing the "i" (27) key. The following message appears on the display (14):

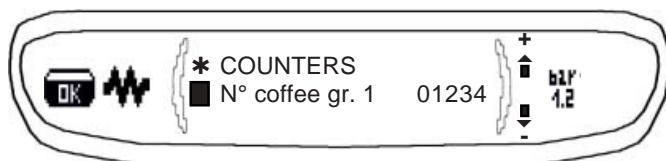

Parameters calculated are:

- **N. coffee** (number of coffee beverages)
- **N. milk** (number of milk beverages)
- **N. water** (number of times water is dispensed)
- **N. steam** (number of times steam is dispensed using the steam button)
- **N. steam TS** (number of times steam is dispensed using the Autosteam function)

- **N. steam + air TS** (number of times steam and air are dispensed using the Autosteam function)
- **N. tot coffee** (total number of coffee beverages).

Counters can be zeroed by aligning the cursor on the selected entry, pressing the PRG (29) key, and then pressing the '+' (30) or "-" (31) key.

Press the "RES" (24) key to confirm zeroing.

The "N. coffee" entry appears for as many times as there are machine groups.

Note: Parameters that cannot be zeroed are:

- **N. tot coffee**

Press the "RES" (24) key to return to the main menu.



# INDEX

	Page
1. Data flow chart - Technician programming	163
2. Programming	164
3. Key menu - Coffee selection	164
3.1 Key menu - Cappuccino - Milk selection	164
3.2 Key menu - Hot water selection	165
4. Configuration menu	165
Autosteam	166
Washing options	167
Wash 1, 2, 3	167
5. Manual control panel	168
6. DATA menu: CoUntERS	169
6.1 DATA menu: Wash 1 Archive	169
6.2 DATA menu: MALFUNCTIONS ARCHIVE	170
6.3 DATA menu: INFO	170
Serial number	170
Version	170
Setup	171
Entering Standard Data	171
Dip settings	171
7. Check-control messages	172



# 1. Data flow chart - Technician programming

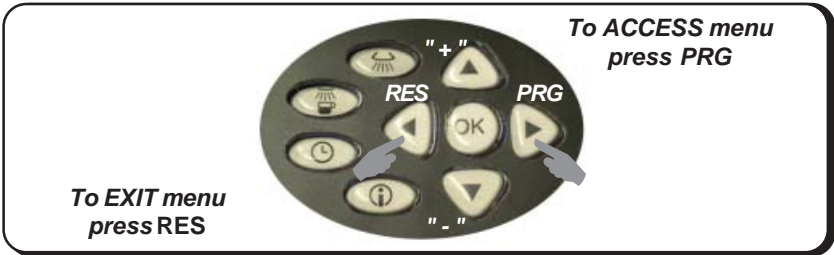

## KEY MENU



### Type



Cappuccino flow

Milk dose

Coffee start/Milk start

Water dose

## CUSTOMER



### SERVICE TIME



#### DATE AND TIME

- ON time
- OFF time
- Day off
- Night ON
- Night OFF
- WASH 1
- WASH 2
- WASH 3

ITALIANO

ENGLISH

FRANCAIS

DEUTSCH

NEDERLANDS

ESPANOL

PORTUGUES

漢語

## CONFIGURATION



### Boiler pressure



## TURBOSTEAM

## MESAUREMENT UNITS

Drying

Time control

Buzzer

Customer prog.

Program. block

Paym system

WASHING OPTIONS

SOFTNER REGENER.

MAINTENANCE

DATA IN/OUT

Standard data

Archive reset

Banner

## TESTING



## MANUAL COMMANDS



## DATA MENU



### COUNTERS



- N° coffee ..
- N° milk
- N° water
- N° steam
- N° steam TS
- N° steam + air TS
- N° tot. coffee

### WASH1 ARCHIVE

- REQUIRED
- PERFORMED

### MALFUNCT. ARCHIVE

INFO

- SERIEL N°
- VERSION SW
- SETUP
- DIP SETTINGS



### EXITING THE PROGRAMMING MENU

Before exiting the menu:

- Press the OK key to confirm any changes to settings;
- Press the RES key to leave settings unchanged

The icons below appear alternately in the bottom part of the display:





## 2. Programming

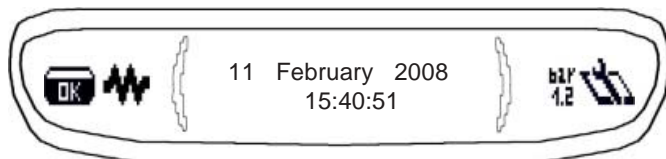

**Display of available menus:** Press the PRG (29) key.

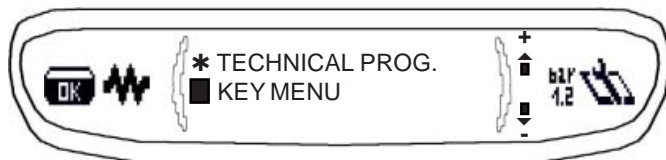

**Access to menus:** Use the "+" (30) and "-" (31) keys to position the cursor on the desired line, then press the PRG (29) key (press a selection key if the "SELECT KEY" menu appears).

**Access and modification of sub-menus:** Use the "+" (30) and "-" (31) keys to position the cursor on the desired line, then press the PRG (29) key.

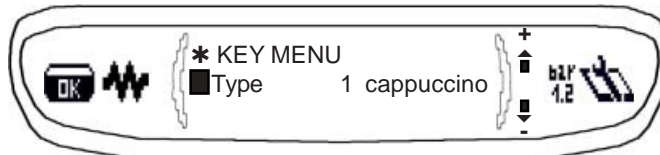

Use the "+" (30) and "-" (31) keys also to modify the message or number.

**Note:** When modifying data, the cursor changes to "→", or a slide bar with maximum and minimum settings will appear:



**Exiting the programming menu:** there are two possibilities:

- 1) Press the **OK** key to confirm changes;
- 2) Press the **RES** key to leave settings unchanged and exit the menu.

## 3. Key menu - Coffee selection

Press one of the coffee dispensing keys (the relative led will remain on, not flashing). The following message will appear on the display:

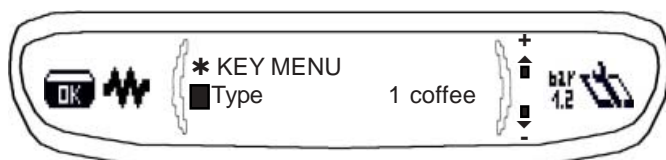

The following coffee selection parameters can be modified:

- **type** (key personalizing, e.g.: 1 coffee, 1 cappuccino, 2 coffee, 2 cappuccini, fast washing, stop, null);
- **water dose** (volumetric dosage pulses, from 0 to 999, with increments of 1);

### 3.1 Key menu - Cappuccino - Milk selection

Press one of the cappuccino – milk dispensing keys. The related LED remains on and does not blink. The display appears as follows:

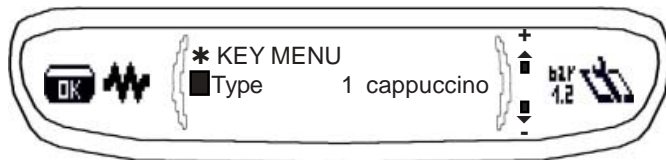

Cappuccino-milk selection parameters that can be changed are:

- **Type** (personalization key, i.e., 1 cappuccino, 2 coffees, 2 cappuccinos, fast wash cycle, stop, disable);
- **Milk dose** (milk dispensing time: 0 ÷ 60 seconds, with increments of 0.1);
- **Milk start/coffee start** \*\* (milk dispensing delayed after coffee dispensing, and vice versa)
- **Water dose** (volumetric dosage pulses: 0 ÷ 999, with increments of 1).

## 3.2 Key menu - Hot water selection

Press the hot water dispensing key (12). The following message will appear on the display:

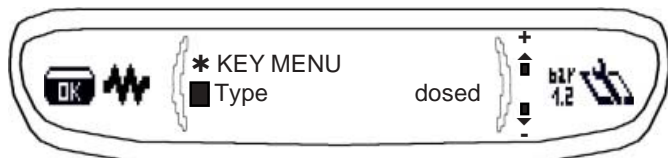

The following hot water selection parameters can be modified:

- **water dispensing time** (dispensing time in seconds.).

## 4. Configuration menu

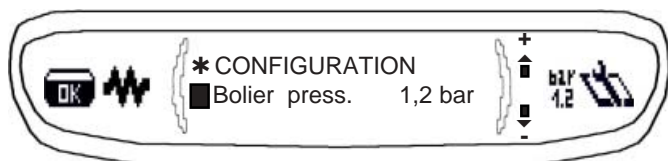

**Boiler pressure** – indicates the boiler pressure: 0,6 ÷ 1,6 bar (9 ÷ 23 psi)

**TURBOSTEAM** - includes 2 sub-menus

*Stop steam temperature* – indicates the automatic stop steam temperature (Turbosteam). Can be set between a minimum of 40 and a maximum of 85° C (104 – 185 ° F).

*Regolator* - flow regulator: YES/ NO.

YES - the machine has the flow regulator on the turbosteam circuit

NO - the machine does not have the flow regulator; is therefore possible to set 4 different levels of emulsion.

If "NO" is set, a third line, "*emulsion level*", appears: here 4 levels can be chosen, where **001** is less emulsion and **004** is continuous emulsion.

See paragraph "*Turbosteam*" on the following pages.

**MEASURING UNIT** – includes 2 sub-menus

**Temperature** – can be set to °C Celsius centigrade or °F Fahrenheit degrees.

**Pressure** – can be set to bar or psi.

**Drying** (pod drying time, from 0 to 5, with increments of 0.1 seconds);

**Time check** - view dispensing time on the display: YES/NO

**Buzzer** - Enable/disable all acoustic warnings both when keys are pressed and when messages appear on the display

**Customer programming** – YES/ NO

**Programming block** - programming block: YES/NO.

With the function active (YES) the use of the programming keyboard is allowed with the technician card; "i" key remains always active.

**Payment system** – permits configuration of payment system, when connected.

**WASHING OPTIONS** - See paragraph "*Washing options*" on the following pages.

**REGENERATION** - includes the parameters for the softener regeneration: liters of resin (da 0,1l a 25l), hardness (da 0 a 45 °F).

**MAINTENANCE** - contains five entries to setting maintenance parameters:

**Max cycles** - the number of cycles initially set: 40,000.

**Max days** - the number of days initially set: 185.

**N° cycles** - the number of cycles remaining before the next maintenance session.

**N° days** - the number of days remaining before the next maintenance session.

**Reset** - options are:

**NO**, countdown of cycles and days remaining before the next maintenance session.

**YES**, the settings for number of cycles (40,000) and remaining days (185) are reset

**OFF**, all controls for programmed maintenance are disabled, and the "N. cycles" and "N. days" counters are zeroed.

**DATA IN/OUT** – contains three entries:

**Key** – indicates the key number from 0 to 60.

**Data** IN transfer from smart card to machine. OUT transfer from machine to smart card.

**TX/RX** – to start data transfer

**Standard data** – loads standard data. YES/NO

**Archive reset** – zeros the error log (Wash 1 Archive and malfunctions archive) stored on the machine: YES/NO

**BANNER** - includes 4 sub-menus

**Enabled** - YES/ NO

**Message 1** - effect, duration.

**Message 2** - effect, duration.

**Message 3** - effect, duration.

For more information on the function please consult the specific leaflet.

## Autosteam Programming function

Once you have selected TURBOSTEAM, use the "+" and "-" keys to position the cursor on the T STOP STEAM line, and press the PRG key.

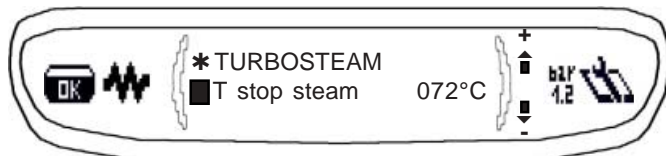

You may now program the automatic steam function, by setting a "xxx°C" temperature value for either hot or whipped milk.

Setting options:

**"0" setting:**

- manual steam stop

**Any number between "40°C ÷ 85°C" (104°F ÷ 185°F)**

- automatic steam stop

**"OFF" setting:**

- steam stop disabled

Use the "+" and "-" keys also to modify the message or number.

## Automatic steam programming

The automatic steam buttons (12) can be programmed in two ways:

### MODE 1, STEAM AUTOMATIC STOP

Set a temperature value on item "T steam xxx°C", by using keys "+" and "-". The range for "xx" is from 40°C (104°F) minimum to 85°C (185°F) maximum.

Steam dispensing is started using: the 12a or 12b buttons.

In particular:

- milk is frothed using the 12a button;
- milk is heated using the 12b button.

When the drink to be heated exceeds +20°C, the message "T steam xxx°C" appears on the display - this indicates the temperature read by the probe.

**N.B.:** When the set temperature is reached, **steam supply stops automatically** and the display continues indicating steam value for the next 3 seconds.

Steam dispensing can be stopped at any moment (even if the set temperature has not been reached), by pressing again either button 12a or button 12b.

### MODE 2, STEAM MANUAL STOP

Set the temperature value on item "T steam xxx°C" at "000" zero.

Steam dispensing and the choice of milk type are performed as in MODE 1.

Press the key (12a or 12b) and the message "T steam xxx°C" immediately appears on the display, indicating the temperature read by the probe.

**Note:** The user controls when steam dispensing is stopped, once the desired temperature has been reached, it will act upon the 12a or 12b buttons.

For the next 3" after steam dispensing has stopped, the display shows the milk temperature that has been reached.

Time out is set at 180" for both the programming modes.

If, when the machine is powered up, the probe does not detect any temperature value (thermo-couple not operating), the STOP STEAM function is disabled and "----" is shown in the setting square instead of "xx°C". The latest set temperature value is, however, saved until thermo-couple operation is restored.

The machine works as if the STOP STEAM function does not exist. Frothed milk and hot milk are available, but the temperature read by the probe will not appear on the display.

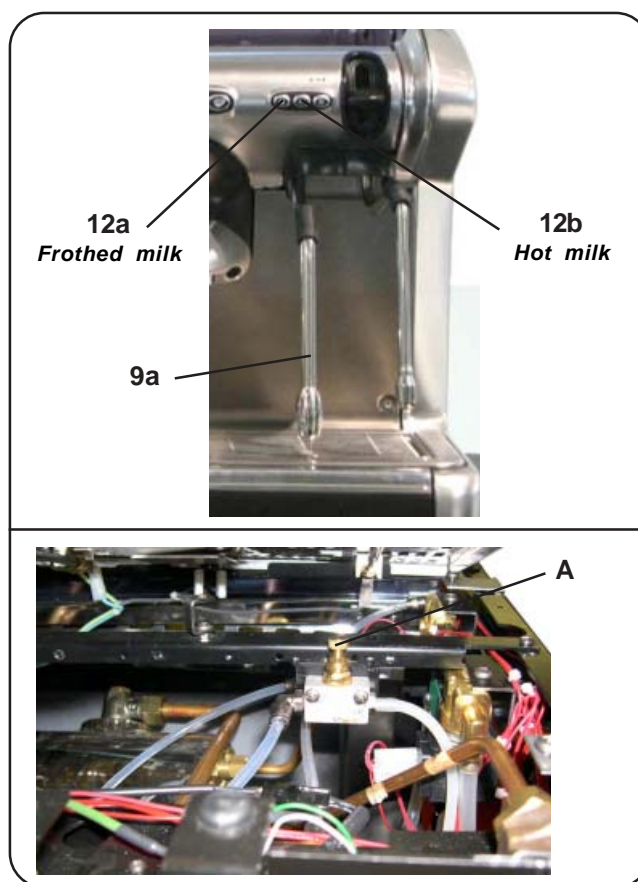

### (Where is present)

The ideal setting for milk frothing is set in the factory. If additional adjustments must be made, turn the flow adjustment valve (A) underneath:

the shelf on the right side of the machine:

- counterclockwise: more air > more frothy milk
- clockwise: less air > less frothy milk

**Note:** even slight turns of the valve (A) can make a great difference in how the milk is frothed.

## Washing options

**WASHING OPTIONS** - includes three sub-menus for setting washing parameters:

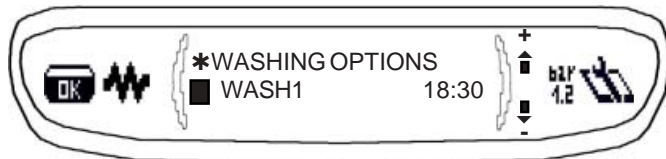

## Wash 1, 2, 3

These are wash cycles set at programmable times, each with four changeable parameters, which are:

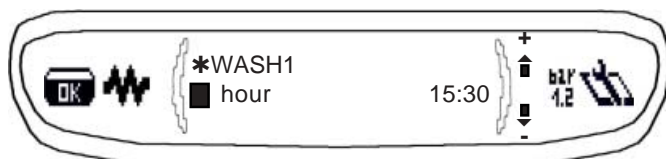

- **hour**: when the wash cycle must be performed. WASH cycles can be disabled and set to OFF.
- **type**: indicates type of wash cycle that will be performed. Long wash (milk circuit and coffee circuit).
- **coffee stop**: when the function (YES) is set, if the wash cycle does not take place within 60' (30' if short washing) from the moment that the "EXECUTE WASHING GROUP" message appears, the machine is blocked and all selections for coffee are disabled.
- **milk stop**: when the function (YES) is set, if the wash cycle does not take place within 60' from the moment that the "EXECUTE WASHING MILK CIRCUIT" message appears, the machine is blocked and all selections for milk are disabled.

NOTE: wash cycles that are not carried out are recorded in the WASH 1 LOG, as "failed".

## 5. Manual control panel

Move the cursor to the "manual" line with the "+" (30) and "-" (31) keys to access the manual control panel.



**MANUAL CONTROLS** – permit parts to be manually operated using the "+" and "-" keys. Press the "PRG" key (29) key, the following message appears on the display:

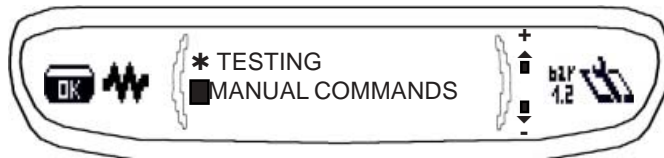

A successive pressure of "PRG" key (29), visualizes on display the following panel:

### Panel 1

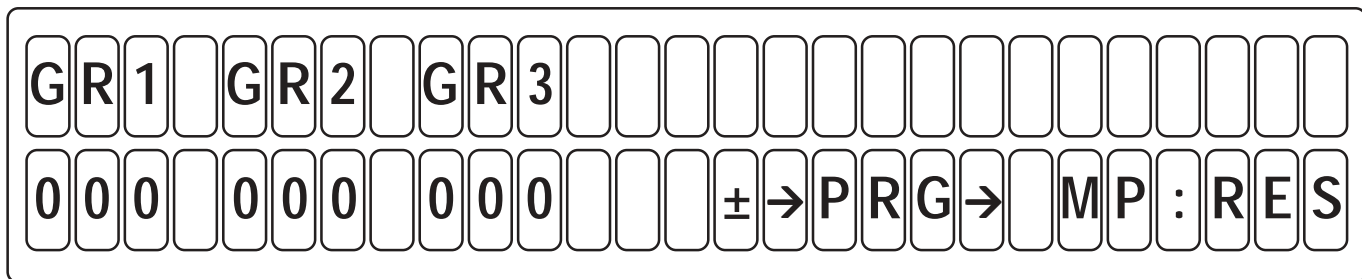

- Press "+" (30) or "-" (31) to display the various components.
- Press "PRG" (29) to select the component to activate and to switch to the next panel M2.
- Press "RES" (24) to quit manual mode.

### Panel 2

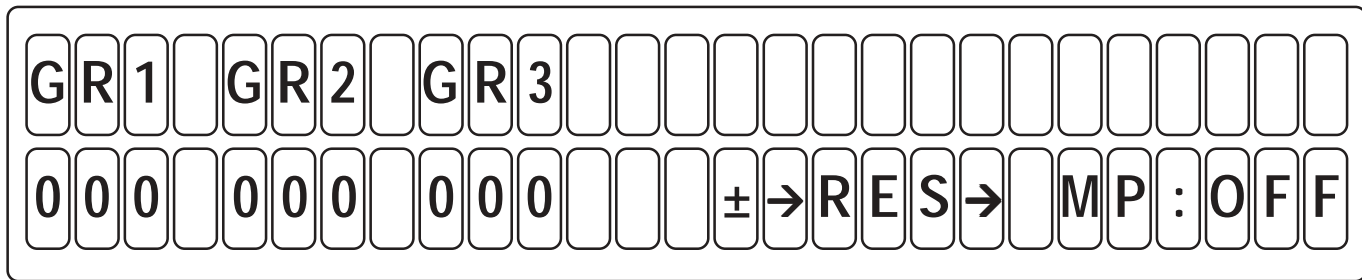

- Press "+" (30) or "-" (31) to activate the components; if they have a direction, use "+" (30) and "-" (31) to alternate the activations (+Lh/-Rh).
- Press "RES" (24) to return to panel M1.

### Legend

1. **GR..** Volumetric meter, displays incremental count, zeroed on entry of M1 menu
2. **xxx** defines the moving part that can be accessed.

Here is the table of symbols used to define the moving parts that can be accessed:

<b>MP</b>	Pump motor
<b>G1÷G4</b>	Coffee dispensing solenoid valve
<b>Eac</b>	Hot water solenoid valve
<b>Evc</b>	Boiler load solenoid valve
<b>Ets</b>	Steam solenoid valve (Turbosteam)
<b>MC</b>	Turbosteam compressor motor
<b>Eds</b>	EDS solenoid valve
<b>Em</b>	Milk solenoid valve

## 6. DATA menu: COUNTERS

Once you have entered the programming menu, access the DATA MENU, pressing the "i" (27) key. The following will be displayed:



Use the "+" (30) and "-" (31) keys to position the cursor on the COUNTER line, then press the PRG (29) key. The following will appear on the display:

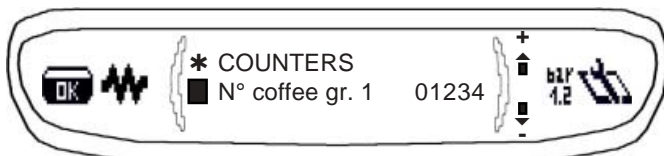

Parameters calculated are:

- **N. coffee** (number of coffee beverages)
- **N. milk** (number of milk beverages)
- **N. water** (number of times water is dispensed)
- **N. steam** (number of times steam is dispensed using the steam button)
- **N. steam TS** (number of times steam is dispensed using the Autosteam function)
- **N. steam + air TS** (number of times steam and air are dispensed using the Autosteam function)

- **N. tot coffee** (total number of coffee beverages).

The "Nr. Coffee" line appears as many times as the number of groups on the machine.

Counters can be zeroed by aligning the cursor on the selected entry, pressing the PRG (29) key, and then pressing the "+" (30) or "-" (31) key.

Note: Parameters that cannot be zeroed are:

- **N. tot coffee**

### 6.1 DATA menu: Wash 1 Archive



Press the "PRG" key (29) key, the following message appears on the display:



The parameters for the WASH 1 log that can appear on the display are:

- **Requests:** number of wash cycles that have been requested by the machine.
- **Executed:** number of wash cycles that were performed within the timeout time of 60'.



NOTE: If the wash cycles requested occur during the timeout, under the entry "Executed" you will also see a list of the last 10 "failed" wash cycles, with progressive number and date. The first line refers to the most recent date.

Use the "+" (30) and "-" (31) keys to scroll through the failed wash cycles, then press the RES (24) key to pass to another menu.



## 6.2 DATA menu: MALFUNCTIONS ARCHIVE



If the PRG (29) key is pressed when the cursor is on the "error log" line, the following appears on the display:

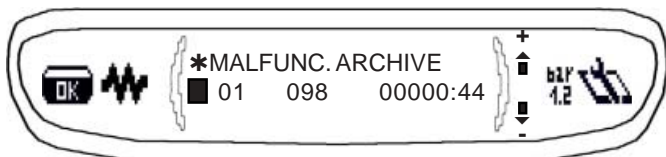

The figures appearing after the "error code" indicate, in hours and minutes, the time that has passed since the last recorded error.

If the PRG (29) key is pressed again, the details page is accessed. The following appears on the display:

- day and hour when the error occurred
- machine groups status when the error occurred.

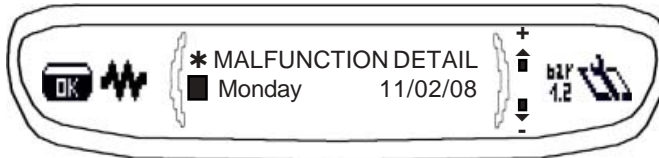

## 6.3 DATA menu: INFO

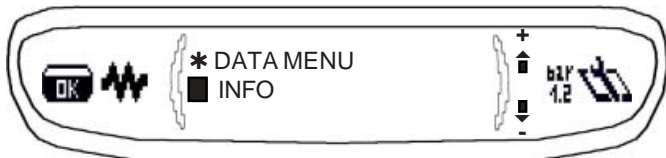

### Serial number

Use the "+" (30) and "-" (31) keys to position the cursor on the INFO line, then press the PRG (29) key. The following will be displayed.

Press the PRG (29) key on the "serial n." line. The following will appear on the display.

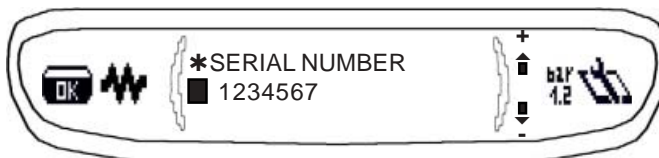

### Version

The sub-menu of the Version entry shows the memory display version and, if present, also the remote control:

When the PRG (29) key is pressed when the cursor is on each of the two lines, besides showing the version, it also displays the data for the revision and memory date.

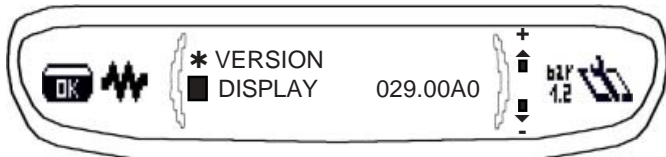

## Setup

The "Setup" entry displays the setup settings introduced during the Data Standard insertion phase:

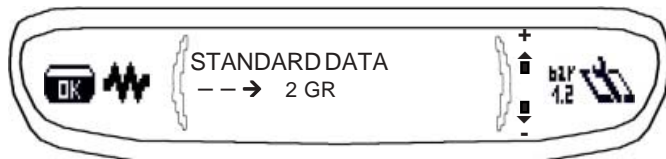

## Entering Standard Data

Before performing this operation, switch off the machine and position **dipswitch 1** on display screen = **ON**, then switch on the machine. If the procedure described above is not performed (dip1=ON), this message will appear on the display:

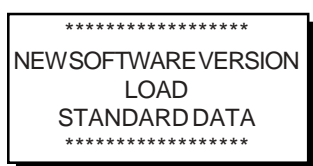

When inputting the Standard Data, you are prompted to input data regarding model and type of machine:

- **MODEL:** 2, 3, 4 groups;
- **TYPE:** coffee, cappuccino 1, cappuccino 2;
- **STEAM:** YES / NO (steam button);
- **TURBOSTEAM:** YES / NO;
- **FEEDING:** electric, electric + gas, gas;
- **MENU:** different types of drinks

Using the "+" key (30) and the "-" key (31), select the parameters, **then press the "PRG" key (29) to confirm the details.**

After this operation, switch off the machine and reset the **dipswitch 1** display screen to **OFF**.

Then:

- Switch on the machine again
- Reset date and time, and reset the desired language, if needed.
- if wished, reset maintenance parameters (see "Configuration menu - Maintenance")
- Zero the error log.

## Dip settings

The "dip setting" entry displays the dipswitch settings.

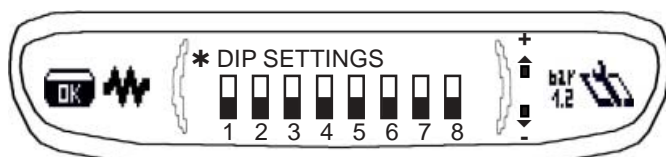

Under standard conditions, the dip-switches are positioned on OFF.

- DIP 1 = OFF - ON Input of standard data
- DIP 2 = OFF
- DIP 3 = OFF - ON Simulation of engineer's key
- DIP 4 = OFF - ON Bookkeeping
- DIP 5 = OFF - ON allows keys sequence to enter programming
- DIP 6 = OFF
- DIP 7 = OFF
- DIP 8 = OFF

For more details, please consult the technical manual at the "Setting - CPU Dip-Switch" paragraph.

## 7. Check-control messages

MALFUN. CODE	DESCRIPTION	POSSIBLE CAUSES	VERIFICATIONS and SOLUTIONS
51	<b>Pressure sensor signal out of range</b>	<ul style="list-style-type: none"> <li>• Sensor failure</li> <li>• Card failure</li> </ul>	<ul style="list-style-type: none"> <li>• Check cabling</li> <li>• Replace the sensor</li> <li>• Replace the card</li> </ul>
52	<b>Boiler heating timeout - 45 minutes</b>	<ul style="list-style-type: none"> <li>• The safety thermocouple has been triggered</li> <li>• The resistance is interrupted (cabling defect)</li> <li>• The Triac card is malfunctioning</li> </ul>	<ul style="list-style-type: none"> <li>• Check if the safety thermostat has been triggered, and reset it if necessary</li> <li>• Check if there are interruptions or detached fastons on the cabling</li> <li>• Check that the boiler resistance is not interrupted and replace it if necessary</li> <li>• Replace the Triac card</li> </ul>
53	<b>Turbosteam thermocouple signal out of range</b>	<ul style="list-style-type: none"> <li>• Thermocuple disconnected</li> <li>• Wrong configuration during standard data insertion</li> </ul>	<ul style="list-style-type: none"> <li>• Enter in the programming mode and insert the correct standard data..</li> <li>• Check connections.</li> <li>• Replace Turbosteam probe.</li> </ul>
58	<b>Boiler overpressure alarm</b> (only for machines with a pressure sensor)	<ul style="list-style-type: none"> <li>• Level probe failure; boiler overfilled.</li> <li>• Resistance always powered.</li> </ul>	<ul style="list-style-type: none"> <li>• Check cabling</li> </ul>
59	<b>Boiler: Refill timeout - 15 minutes</b>	<ul style="list-style-type: none"> <li>• No water</li> <li>• Refill EV failure</li> <li>• Wiring interrupted</li> <li>• Card failure</li> </ul>	
66	<b>Irregular dose coffee cycle</b>	<ul style="list-style-type: none"> <li>• No water</li> <li>• Flowmeter failure</li> <li>• Water circuit blocked</li> <li>• Wiring interrupted/ grounded</li> </ul>	<ul style="list-style-type: none"> <li>• Check water is supplied from the main line.</li> <li>• Check there are no fitting obstructions or leakage.</li> <li>• Check flowmeter electrical connections.</li> <li>• Replace the broken flowmeter.</li> <li>• Replace the broken board.</li> </ul>
67	<b>Group wash: Irregular dispensing EV dispensing</b>	<ul style="list-style-type: none"> <li>• No water</li> <li>• Flowmeter failure</li> <li>• Water circuit blocked</li> <li>• Wiring interrupted/ grounded</li> </ul>	<ul style="list-style-type: none"> <li>• See code 66.</li> <li>• Check the G solenoid valve is working.</li> <li>• Replace the valve when broken.</li> </ul>
96	<b>Maintenance needed</b>		<ul style="list-style-type: none"> <li>• The machine is displaying a message to advice the user that maintenance is needed. Carry out maintenance operations.</li> </ul>
98	<b>Historical malfunctions and wash 1 reset</b>	<ul style="list-style-type: none"> <li>• Breakdown log initialization.</li> </ul>	
99	<b>Default data input</b>		

**Collegamento elettrico - Electric connection - Branchement électrique  
Stromanschluss - Conexión eléctrica - Ligação eléctrica**

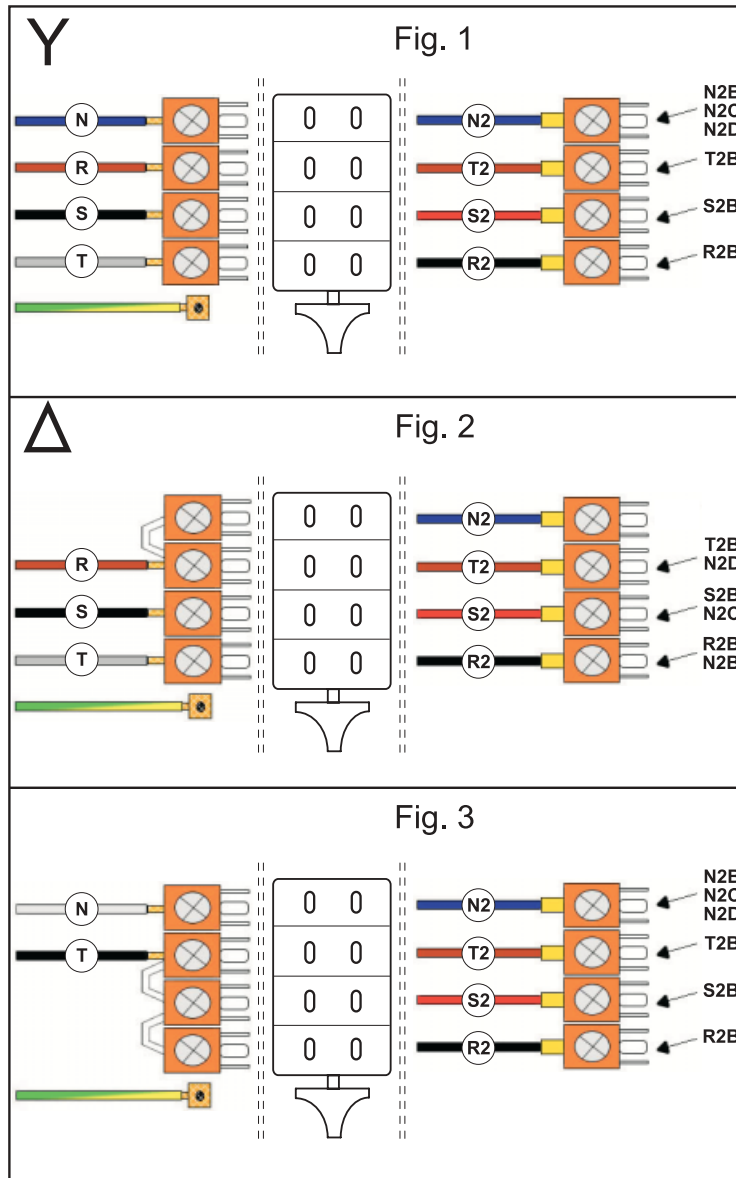

**Colore cavi - Wires colour - Couleur cables - Farbe der Drähte - Color cables - Cor cabos**

*Macchine con collegamento trifase  
Machines with three-phase connection  
Machines à raccordement triphasé  
Maschinen mit dreiphasig Anschluß  
Máquinas con conexión trifásica  
Máquinas com ligação trifásica*

- T** Grigio (Nero) - Grey (Black) - Gris (Noir)  
Grau (Schwarz) - Gris (Negro) - Cinza (Preto)
- S/R2** Nero - Black - Noir  
Schwarz - Negro - Preto
- R/T2** Marrone - Brown - Brun  
Braun - Maròn - Marron
- NN2** Azzurro - Blue - Bleu  
Blau - Azùl - Azul
- S2** Rosso - Red - Rouge  
Rot - Rojo - Vermelho

*Macchine con collegamento monofase  
Machines with single phase connection  
Machines à raccordement monophasé  
Maschinen mit einphasigem Anschluß  
Máquinas con conexión monofásica  
Máquinas com ligação mono-fásica*

- N** Bianco - White - Blanc  
Weiß - Blanco - Branco
- T** Nero - Black - Noir  
Schwarz - Negro - Preto

1

- N** Azzurro - Blue - Bleu  
Blau - Azùl - Azul
- T** Marrone - Brown - Brun  
Braun - Maròn - Marron

2

# Schema elettrico - Wiring diagram - Schéma électrique - Elektrischer Schaltplan - Esquema electrico - Esquema eléctrico

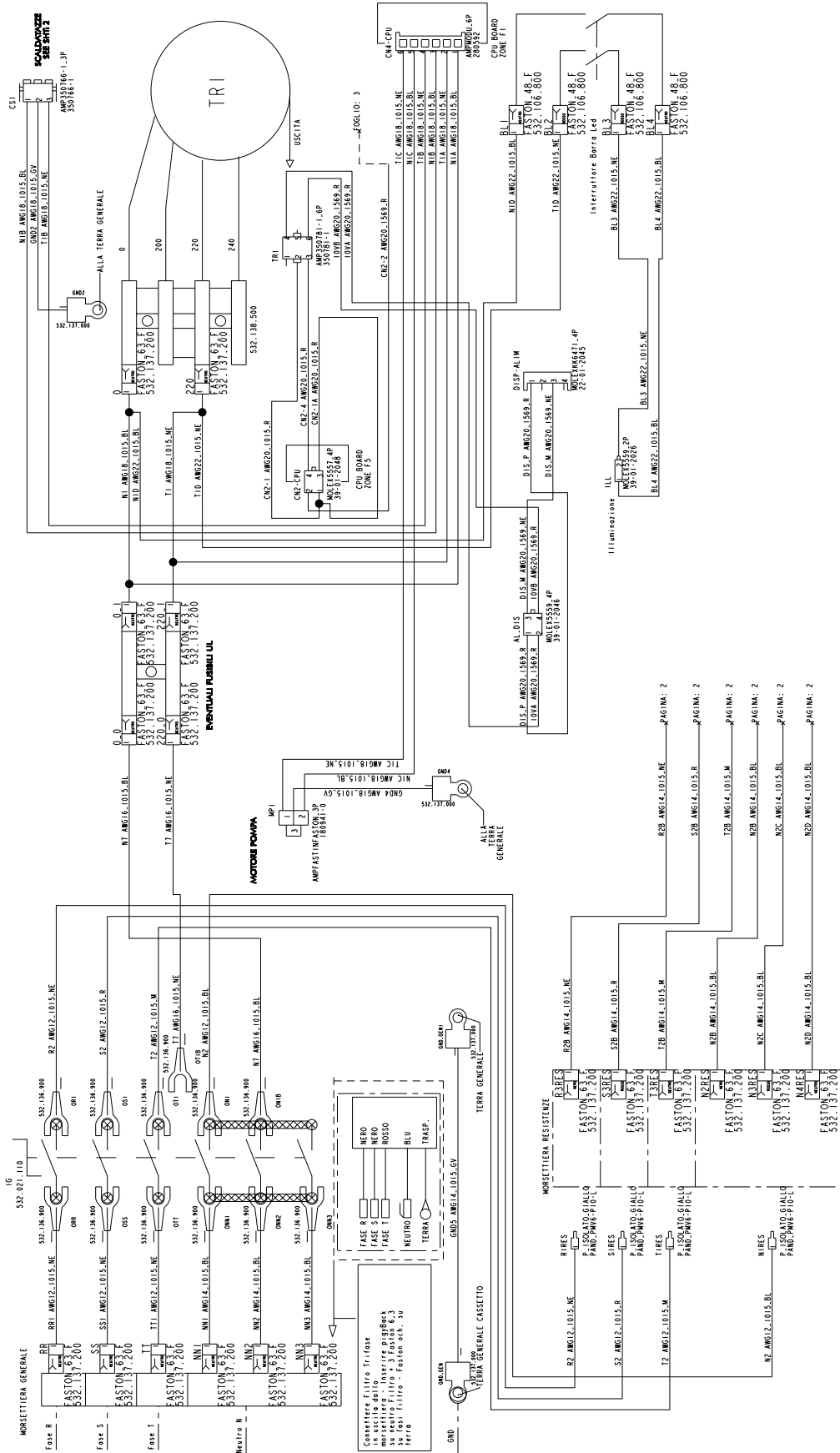

DEGNOMINAZIONE  
 - E93 WIRLING DIAGRAM  
 PAGE 1 OF 6

Schema elettrico - Wiring diagram - Schéma électrique -  
Elektrischer Schaltplan - Esquema electrico - Esquema eléctrico

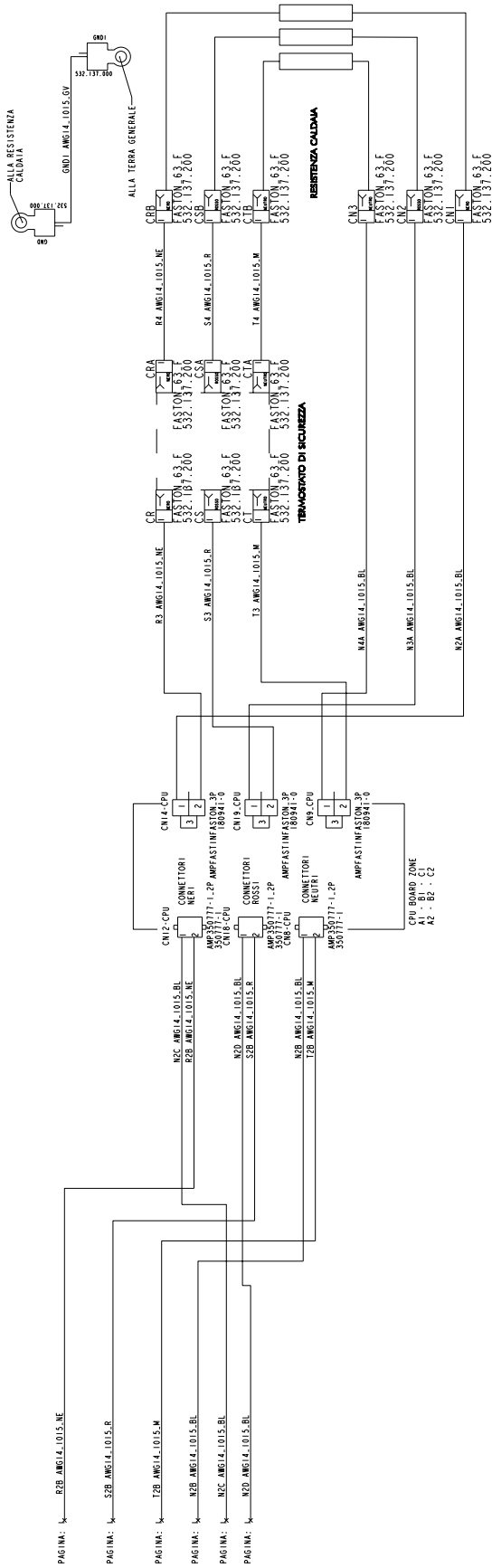

DENOMINAZIONE

E93 WIRING DIAGRAM

PAGE 2 OF 6



# Schema elettrico - Wiring diagram - Schéma électrique - Elektrischer Schaltplan - Esquema electrico - Esquema eléctrico

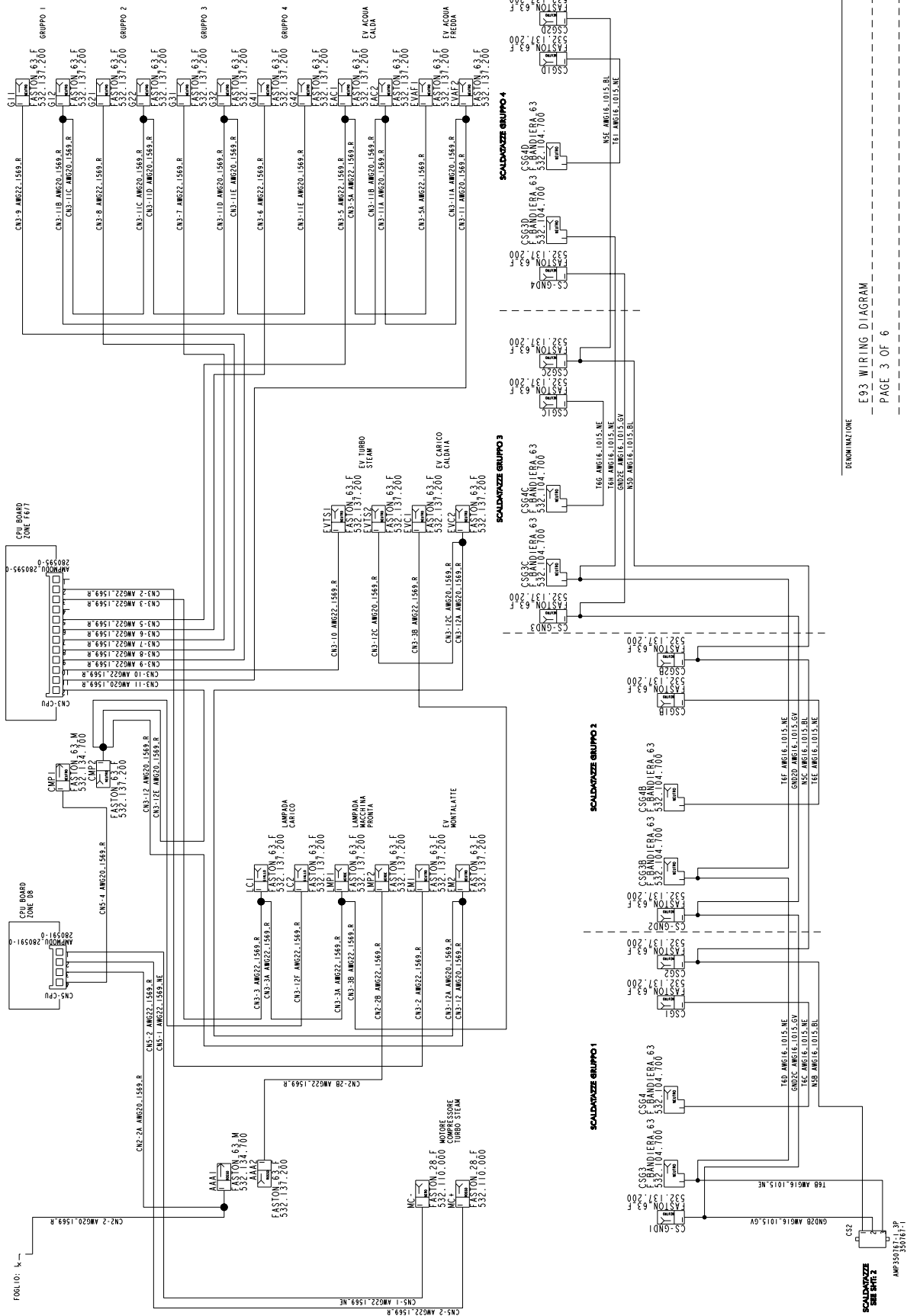

DEGNOMINAZIONE  
E93 WIRING DIAGRAM  
PAGE 3 OF 6

# Schema elettrico - Wiring diagram - Schéma électrique - Elektrischer Schaltplan - Esquema electrico - Esquema eléctrico

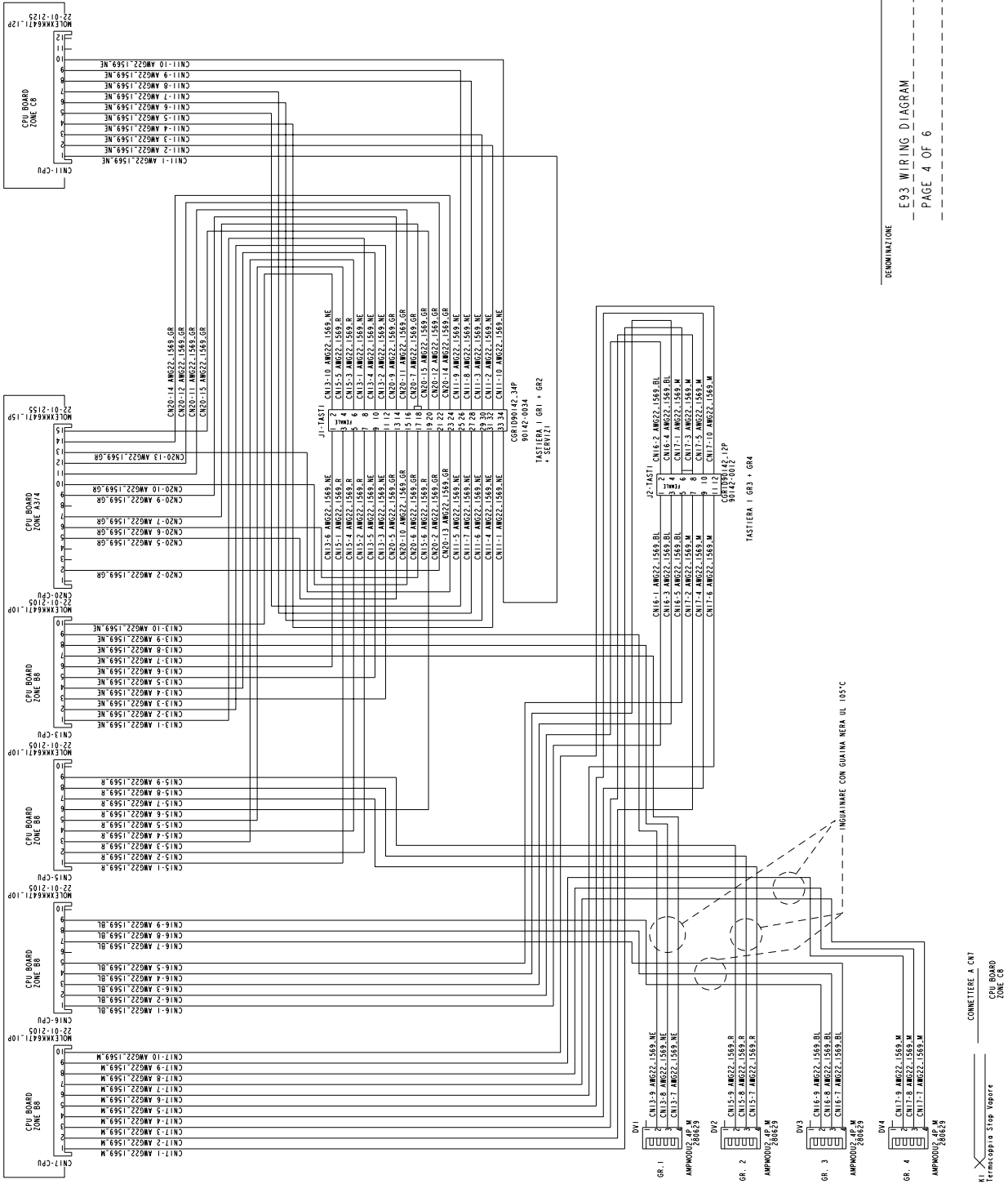

E93\_WIRING DIAGRAM  
PAGE 4 OF 6

# Schema elettrico - Wiring diagram - Schéma électrique - Elektrischer Schaltplan - Esquema electrico - Esquema eléctrico

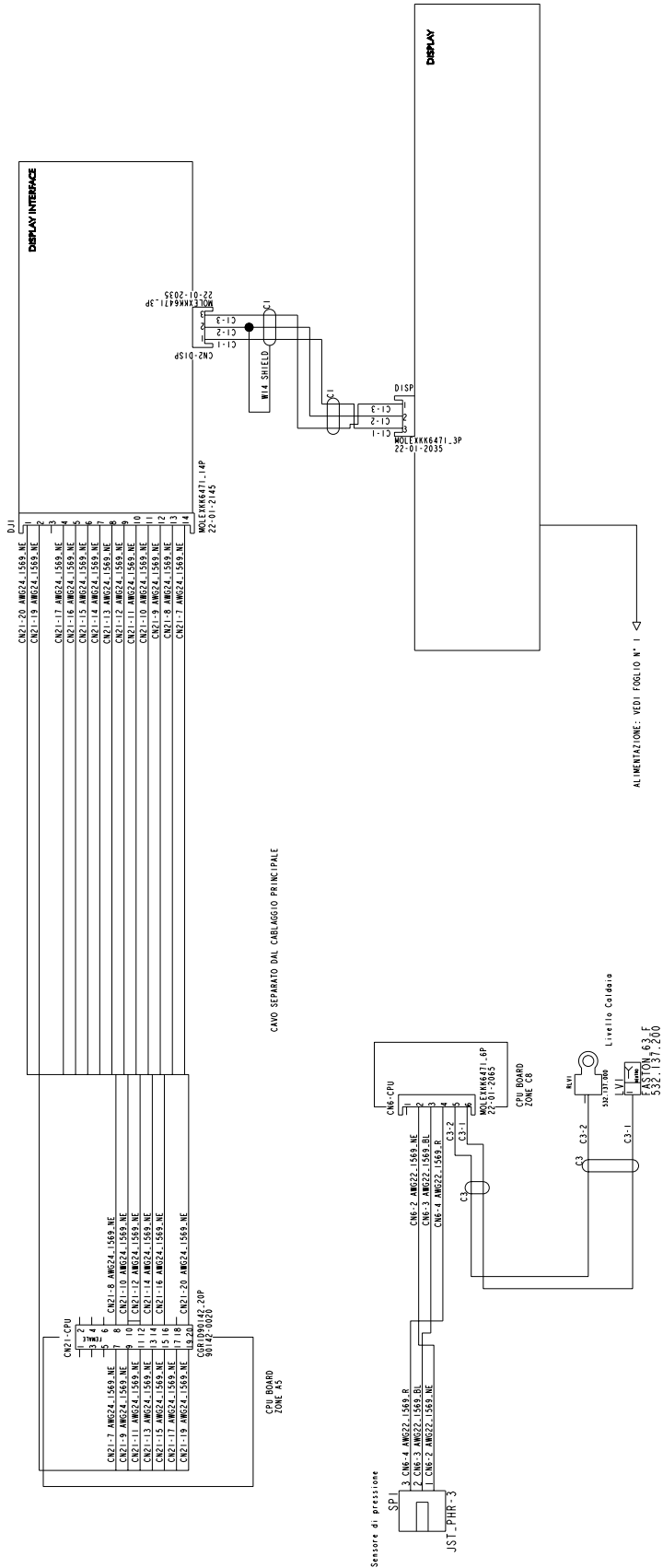

DEGNOMAZIONE

— E93 WIRING DIAGRAM —

— PAGE 5 OF 6 —



**Circuito idraulico - Hydraulic circuit - Circuit hydraulique  
Hydraulikplan - Circuito hidraulico - Circuito hidráulico**

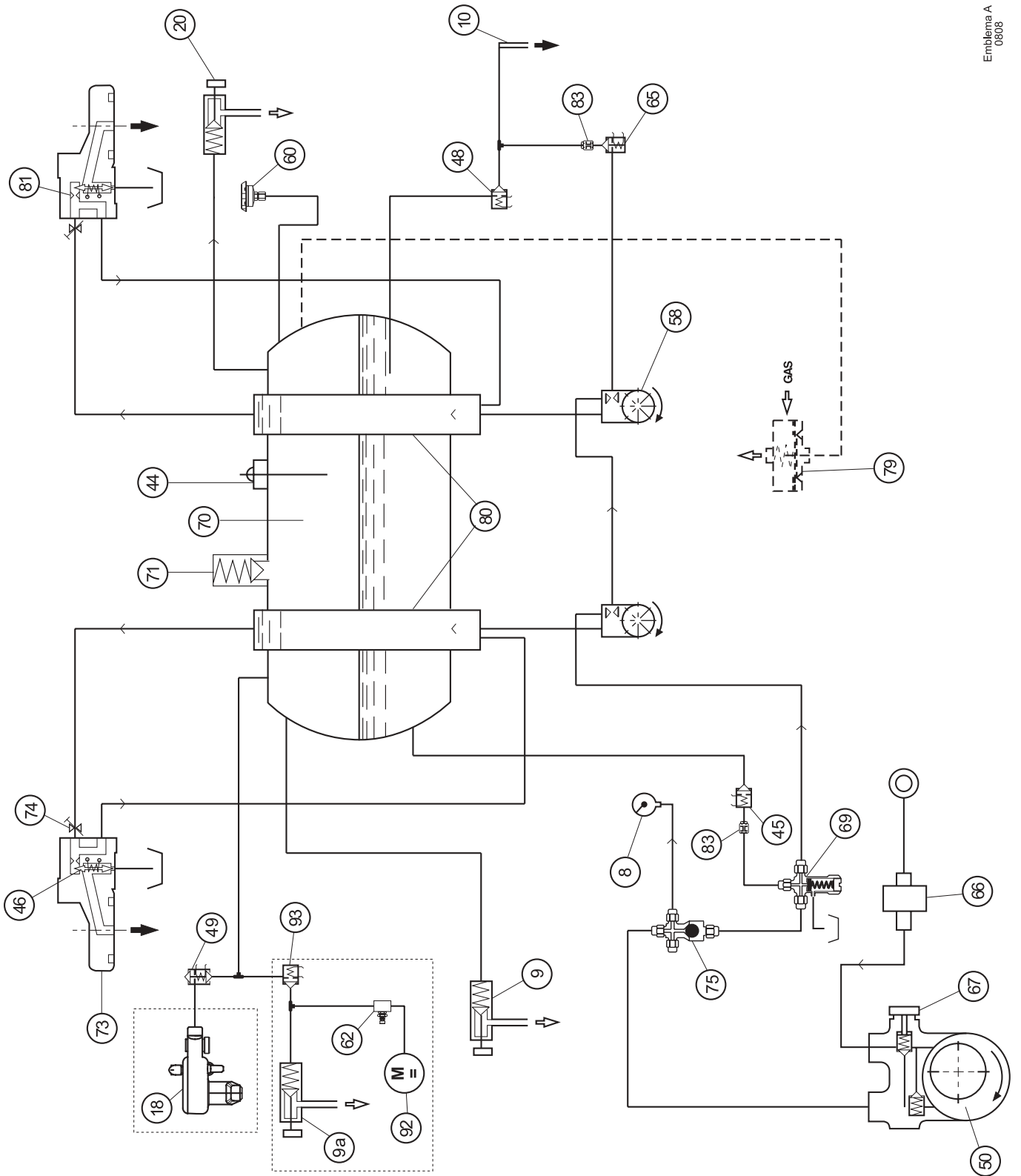

Emblema A  
0808

# Circuito idraulico - Hydraulic circuit - Circuit hydraulique Hydraulikplan - Circuito hidraulico - Circuito hidráulico

## F LEGENDA

- 8 = Manometro/reseau/pompe
- 9 = Lance droite débit vapeur
- 9a = Lance Autosteam (\*)
- 10 = Lance débit eau chaude
- 18 = Cappuccinatore
- 20 = Lance gauche débit vapeur
- 44 = Sonda niveau automatique
- 45 = Electrovalve niveau
- 46 = Electrovalve groupe
- 48 = Electrovalve eau chaude
- 49 = Electrovalve cappuccinateur
- 50 = Moteur pompe
- 58 = Petite turbine
- 60 = Détecteur de pression
- 62 = Regulateur de air
- 65 = Electrovalve eau froide
- 66 = Filtre pour la pompe
- 67 = Réglage de la pression de la pompe
- 69 = Valve d'expansion
- 70 = Chaudière
- 71 = Valve de sécurité
- 73 = Groupe de débit
- 74 = Etrangement du groupe
- 75 = Valve de non retour de la chaudière
- 79 = Autorégulateur de gaz (\*)
- 80 = Echangeurs de chaleur
- 81 = Injecteur de groupe
- 83 = Injecteur
- 92 = Moteur compresseur \*
- 93 = Electrovanne Autosteam \*

Les détails - \* - ne sont appliqués qu'à certaines configurations de produit.

## P LEGENDA

- 8 = Manómetro rede/bomba
- 9 = Lança direita de distribuição do vapor
- 9a = Lança autosteam (\*)
- 10 = Lança de distribuição da água quente
- 18 = Preparador de cappuccino
- 20 = Lança esquerda de distribuição do vapor
- 44 = Sonda de auto-nível
- 45 = Electro-válvula nível
- 46 = Electro-válvula grupo
- 48 = Electro-válvula da água quente
- 49 = Electro-válvula do preparador de cappuccino
- 50 = Motor da bomba
- 58 = Turbina
- 60 = Sensor pressão
- 62 = Dispositivo de regulação do ar
- 65 = Electro-válvula da água fria
- 66 = Filtro para bomba
- 67 = Regulação da pressão da bomba
- 69 = Válvula de expansão
- 70 = Caldeira
- 71 = Válvula de segurança
- 73 = Grupo de distribuição
- 74 = Estrangulamento do grupo
- 75 = Válvula de não retorno da caldeira
- 79 = Auto-regulador do gás (\*)
- 80 = Permutadores de calor
- 81 = Injetor do grupo
- 83 = Injetor
- 92 = Motor compressor \*
- 93 = Electro-válvula Autosteam \*

Os componentes \*\* - são aplicados apenas sobre algumas configurações de produtos

## GB LEGEND

- 8 = Pump pressure gauge
- 9 = Right steam dispensing nozzle
- 9a = Turbosteam pipe (\*)
- 10 = Hot water dispensing nozzle
- 18 = Cappuccino maker
- 20 = Left steam dispensing nozzle
- 44 = Automatic level probe
- 45 = Level solenoid valve
- 46 = Group solenoid valve
- 48 = Hot water solenoid valve
- 49 = Cappuccino solenoid valve
- 50 = Pump motor
- 58 = Turbine
- 60 = Pressure sensor
- 62 = Air regulator
- 65 = Cold water solenoid valve
- 66 = Pump filter
- 67 = Pump pressure regulator
- 69 = Expansion valve
- 70 = Boiler
- 71 = Safety valve
- 73 = Coffee dispenser group
- 74 = Dispenser neck
- 75 = Boiler non return valve
- 79 = Gas autoregulator (\*)
- 80 = Heat exchangers
- 81 = Dispenser group injector
- 83 = Injector
- 92 = Motor compressor \*
- 93 = Autosteam solenoid valve \*

Items marked \* - are fitted in some product configurations only.

## E LEGENDA

- 8 = Manómetro red/bomba
- 9 = Tubo derecho erogación vapor
- 9a = Tubo autosteam (\*)
- 10 = Tubo erogación agua caliente
- 18 = Cappuccinador
- 20 = Tubo izquierda erogación vapor
- 44 = Sonda autonivel
- 45 = Electroválvula nivel
- 46 = Electroválvula grupo 2
- 48 = Electroválvula agua caliente
- 49 = Electroválvula cappuccinador
- 50 = Motor Bomba
- 58 = Turbina
- 60 = Sensor presión
- 62 = Regulador aire
- 65 = Electroválvula agua fría
- 66 = Filtro para bomba
- 67 = Regulación presión bomba
- 69 = Válvula expansión
- 70 = Caldera
- 71 = Válvula de seguridad
- 73 = Grupo erogador
- 74 = Estrangulación grupo
- 75 = Válvula de retención caldera
- 79 = Autorregulador gas (\*)
- 80 = Cambiadores de calor
- 81 = Inyector grupo
- 83 = Inyector
- 92 = Motor compresor \*
- 93 = Electroválvula Autosteam \*

Los detalles - \* - se pueden aplicar sólo en algunas configuraciones del producto.

## I LEGENDA

- 8 = Manometro/rete/pompa
- 9 = Lancia destra erogazione vapore
- 9a = Lancia Autosteam (\*)
- 10 = Lancia erogazione acqua calda
- 18 = Cappuccinatore
- 20 = Lancia sinistra erogazione vapore
- 44 = Sonda autolivello
- 45 = Elettrovalvola livello
- 46 = Elettrovalvola gruppo
- 48 = Elettrovalvola acqua calda
- 49 = Elettrovalvola cappuccinatore
- 50 = Motore pompa
- 58 = Turbinetta
- 60 = Sensore pressione
- 62 = Regolatore Aria
- 65 = Elettrovalvola acqua fredda
- 66 = Filtro per pompa
- 67 = Regolazione pressione pompa
- 69 = Valvola espansione
- 70 = Caldaia
- 71 = Valvola di sicurezza
- 73 = Gruppo erogatore
- 74 = Sirozzatura gruppo
- 75 = Valvola non ritorno caldaia
- 79 = Autoregolatore gas (\*)
- 80 = Scambiatori di calore
- 81 = Iniettori gruppo
- 83 = Iniettori
- 92 = Motore compressore \*
- 93 = Elettrovalvola Autosteam \*

I componenti - \* - sono applicati solo su alcune configurazioni di prodotti.

## D LEGENDE

- 8 = Druckmesser Pumpe
- 9 = rechter Strahler Dampfabgabe
- 9a = Dampfstrahler turboteam (\*)
- 10 = Strahler Heißwasserabgabe
- 18 = Cappuccinozubereitung
- 20 = linker Strahler Dampfabgabe
- 44 = Fühler automatische Standanzeige
- 45 = Magnetventil Stand
- 46 = Magnetventil Abgabeinheit
- 48 = Magnetventil Heißwasserabgabe
- 49 = Magnetventil Cappuccino-Zubereitung
- 50 = Pumpenmotor
- 58 = Turbine
- 60 = Druckfühler
- 62 = Lüftregler
- 65 = Kaltwasser Magnetventil
- 66 = Pumpenfilter
- 67 = Einstellung Pumpendruck
- 69 = Überlaufventil
- 70 = Heizkessel
- 71 = Sicherheitsventil
- 73 = Abgabeinheit
- 74 = Drossler Abgabeinheit
- 75 = Rückschlagventil Heizkessel
- 79 = Selbstreglung Gas (\*)
- 80 = Wärmetauscher
- 81 = Injektor
- 83 = Injektor
- 92 = Motor Kompressor \*
- 93 = Magnetventil Autosteam \*

Die mit - \* - gekennzeichneten Komponenten sind nur in bestimmten Modellen installiert.





**I**

GRUPPO CIMBALI S.p.A.  
Via A. Manzoni, 17  
20082 Binasco  
(MI) Italy  
Tel. ..39 2 90.04.91 / 90.04.81  
Fax ..39 2 90.54.818 / 90048486  
[www.faema.it](http://www.faema.it)

GRUPPO CIMBALI si riserva il diritto di apportare cambiamenti all'equipaggiamento della macchina a seconda delle esigenze di singoli Paesi e di effettuare modifiche dovute agli avanzamenti del progresso tecnico.

Nessuna parte di questa pubblicazione può essere usata, copiata o pubblicata senza il permesso scritto di GRUPPO CIMBALI S.p.A.

© Copyright by GRUPPO CIMBALI S.p.A., Milano  
Tutti i diritti riservati

**GB**

GRUPPO CIMBALI S.p.A.  
Via A. Manzoni, 17  
20082 Binasco  
(MI) Italy  
Tel. ..39 2 90.04.91 / 90.04.81  
Fax ..39 2 90.54.818 / 90048486  
[www.faema.it](http://www.faema.it)

GRUPPO CIMBALI reserves the right to make changes to the machines in accordance with the needs of individual countries and on the basis of technological progresses.

This publication may not, either in whole or in part, be used, copied or published without the written authorisation of

GRUPPO CIMBALI S.p.A.

© Copyright by GRUPPO CIMBALI S.p.A., Milan, Italy  
All rights reserved

**F**

GRUPPO CIMBALI S.p.A.  
Via A. Manzoni, 17  
20082 Binasco  
(MI) Italy  
Tel. ..39 2 90.04.91 / 90.04.81  
Fax ..39 2 90.54.818 / 90048486  
[www.faema.it](http://www.faema.it)

La société GRUPPO CIMBALI se réserve le droit d'apporter des changements à l'équipement de la machine selon les exigences des pays, et d'effectuer des modifications dues aux avancements du progrès technique.

Aucune partie de cette publication ne peut être utilisée, copiée ou publiée sans l'autorisation écrite de GRUPPO CIMBALI S.p.A.

© Copyright by GRUPPO CIMBALI S.p.A., Milano  
Tous droits réservés

**D**

GRUPPO CIMBALI S.p.A.  
Via A. Manzoni, 17  
20082 Binasco  
(MI) Italy  
Tel. ..39 2 90.04.91 / 90.04.81  
Fax ..39 2 90.54.818 / 90048486  
[www.faema.it](http://www.faema.it)

GRUPPO CIMBALI behält sich vor, Änderungen der Maschine entsprechend den spezifischen nationalen Gegebenheiten sowie entsprechend dem Fortschritt der Technik vornehmen zu können.

Die vorliegende Veröffentlichung darf in keinen Teilen ohne entsprechende Genehmigung der Firma GRUPPO CIMBALI S.p.A. vervielfältigt, kopiert oder veröffentlicht werden.

© Copyright by GRUPPO CIMBALI S.p.A., Milano  
Alle Rechte vorbehalten

**E**

GRUPPO CIMBALI S.p.A.  
Via A. Manzoni, 17  
20082 Binasco  
(MI) Italy  
Tel. ..39 2 90.04.91 / 90.04.81  
Fax ..39 2 90.54.818 / 90048486  
[www.faema.it](http://www.faema.it)

GRUPPO CIMBALI se reserva el derecho de aportar cambios al equipamiento de la máquina según las exigencias de cada uno de los países y de realizar modificaciones debidas a los desarrollos del progreso técnico.

Ninguna parte de esta publicación se puede usar, copiar o publicar sin el permiso escrito de GRUPPO CIMBALI S.p.A.

© Copyright by GRUPPO CIMBALI S.p.A., Milán  
Todos los derechos están reservados

**P**

GRUPPO CIMBALI S.p.A.  
Via A. Manzoni, 17  
20082 Binasco  
(MI) Italy  
Tel. ..39 2 90.04.91 / 90.04.81  
Fax ..39 2 90.54.818 / 90048486  
[www.faema.it](http://www.faema.it)

GRUPPO CIMBALI reserva-se o direito de modificar o equipamento da máquina segundo as exigências de cada País e efectuar alterações devidas aos avanços do progresso tecnológico.

Nenhuma parte desta publicação poderá ser utilizada, copiada ou publicada sem autorização escrita de GRUPPO CIMBALI S.p.A.

© Copyright by GRUPPO CIMBALI S.p.A., Milano  
Todos os direitos são reservados

## SERVICE LINE

### I FAEMA e il "SERVICE LINE"

Il servizio assistenza della società FAEMA, nell'intento di essere vicino ai SIGG. Clienti nella scelta dei prodotti per il miglior utilizzo della macchina da caffè, visualizza la linea:

**ECO LINE** - Prodotti per la pulizia

- |                |            |   |
|----------------|------------|---|
| A) 4991-134458 | liquido    | per i cappuccinatori;                           |
| B) 4991-134682 | in polvere | per i gruppi, i portafiltri, le tazze da caffè; |
| C) 4991-134681 | bustine    | per i gruppi, i portafiltri, le tazze da caffè; |
| D) 4991-134683 | pastiglie  | per i gruppi nelle macchine superautomatiche.   |

Per ordinare trasmettete il numero di codice al Vs. Concessionario.

### GB FAEMA and the "SERVICE LINE"

The FAEMA Company's client service, the aim of which is to assure top coffee-machine performance for its clients at all times, also makes available its ECO LINE, a series of specific cleaning products expressly designed for this purpose.

**ECO LINE** - Cleaning products

- |  |                    |              |
|--|--------------------|--------------|
| A) For cappuccino makers                       | in liquid form     | 4991-134458; |
| B) For dispensers, filter-holders, coffee cups | in powder form     | 4991-134682; |
| C) For dispensers, filter-holders, coffee cups | in small envelopes | 4991-134681; |
| D) For superautomatic-machine dispensers       | in tablet form     | 4991-134683. |

Order directly from your local distributor and refer to the particular item you require by its number, as shown above.

### F FAEMA et la "SERVICE LINE"

La service d'assistance de la société FAEMA, dans l'intention d'être à côté de ses clients, dans le choix des produits et en vue d'une meilleure utilisation de la machine à café, propose la ligne:

**ECO LINE** - Produits de nettoyage

- |                |           |  |
|----------------|-----------|--|
| A) 4991-134458 | liquide   | pour les fouettes-lait;                                |
| B) 4991-134682 | en poudre | pour les groupes, les porte-filtre, les tasses à café; |
| C) 4991-134681 | sachets   | pour les groupes, les porte-filtre, les tasses à café; |
| D) 4991-134683 | pastilles | pour les groupes des machines tout-auto.               |

Pour commander, transmettre le numéro de code à votre concessionnaire.

### D FAEMA und die "SERVICE LINE"

Mit der Absicht dem Kunden bei der Produktwahl für den bestmöglichen Gebrauch der Kaffeemaschine beizustehen, weist der Kundendienst der FAEMA Gesellschaft auf folgende Produktlinie hin:

**ECO LINE** - Produkte für die Säuberung

- |                |               |  |
|----------------|---------------|--|
| A) 4991-134458 | Flüssig       | für die Cappuccino-Bereiter;                         |
| B) 4991-134682 | in Pulverform | für die Gruppen, die Filterhalter, die Kaffeetassen; |
| C) 4991-134681 | Tüten         | für die Gruppen, die Filterhalter, die Kaffeetassen; |
| D) 4991-134683 | Tabletten     | für die Kaffeegruppen der vollautomat Maschinen.     |

Für eine Bestellung bitte dem Vertreter die Katalog-Nr. angeben.

### E FAEMA y el "SERVICE LINE"

Con el deseo de facilitar a los Srs. CLIENTES la selección de los productos para el uso correcto de la máquina de café, el servicio de asistencia de la sociedad FAEMA les muestra la línea:

**ECO LINE** - Productos para la limpieza

- |                |              |  |
|----------------|--------------|--|
| A) 4991-134458 | líquido      | para los cappuccinadores;                              |
| B) 4991-134682 | en polvos    | para los equipos, los portafiltros, las tazas de café; |
| C) 4991-134681 | en sobres    | para los equipos, los portafiltros, las tazas de café; |
| D) 4991-134683 | en pastillas | para los equipos de las máquinas superautomáticas.     |

Para los pedidos, envíe el número de código a su Concesionario.

### P FAEMA e o "SERVICE LINE"

O Serviço de Assistência de empresa FAEMA, com a finalidade de aconselhar os Clientes na escolha dos produtos para a melhor utilização da máquina de café, apresenta a linha:

**ECO LINE** - Produtos para a limpeza

- |                |           |   |
|----------------|-----------|---|
| A) 4991-134458 | líquido   | para o kit cappuccino;                                  |
| B) 4991-134682 | en pó     | para os grupos, manípulo dos filtros, chávenas de café; |
| C) 4991-134681 | carteiras | para os grupos, manípulo dos filtros, chávenas de café; |
| D) 4991-134683 | pastilhas | para os grupos das máquinas superautomáticas.           |

Para encomendar, indicar o número de código ao seu Concessionário.